

SOJAG

produits saisonniers • seasonal products

Sojag code: 500-8164077

CUP/UPC code: 772830164077

QUESTIONS? 1 866-659-4402

Assembly Manual / Guide d'assemblage / Manual de ensamblaje / 조립 설명서 / Montageanleitung

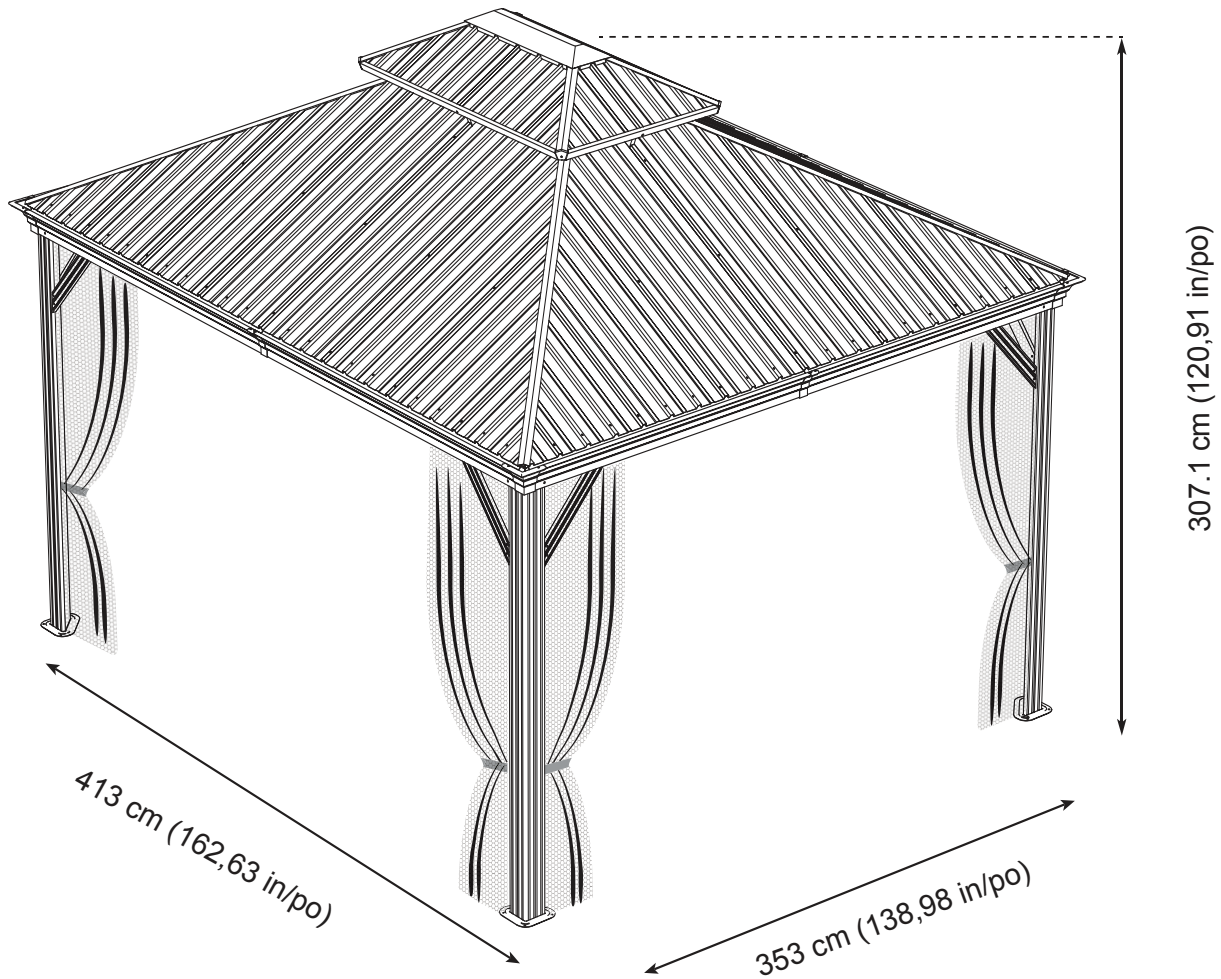

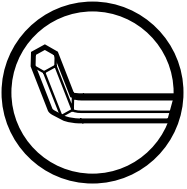

Use the hex keys in the box. / Utiliser les clés hexagonales fournies dans la boîte. /
Utilice las llaves hexagonales en la caja. / 상자에 육각 키를 사용 하십시오. / Verwenden Sie
die Sechskantschlüssel in der Box.

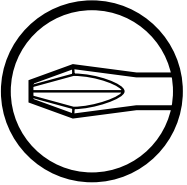

Please use a Phillips screwdriver. / Utiliser un tournevis de type Phillips / Por favor, use
un destornillador Phillips / 십자 드라이버를 사용 하십시오. / Bitte verwenden Sie einen
Kreuzschraubenzieher.



You may need to use a drill for this step. / Cette étape peut nécessiter l'utilisation
d'une perceuse. / puede que tenga que utilizar un taladro para este paso. /
이 단계에선 드릴을 사용해야 할 수도 있습니다. / Für diesen Schritt können Sie einen
Bohrer verwenden.



Wearing protective gloves is recommended. / Le port de gants de protection est recommandé /
El uso de guantes de protección se recomienda / 보호 장갑을 착용 하는 것이 좋습니다. /
Das Tragen von Schutzhandschuhen wird empfohlen.



Two or more people are required at this stage. / Deux personnes ou plus sont nécessaires à cette
étape. / Dos o más personas se requieren en esta etapa. / 이 단계에서는 두 명 이상이 필요합니다. /
Für diesen Bauschritt sind 2 oder mehr Personen erforderlich.



Do not screw firmly for now. / Ne pas visser fermement pour l'instant. / No atornille con
firmeza por ahora. / 아직 나사를 단단히 조이지 마십시오. / Bitte die Schrauben zum
jetzigen Zeitpunkt noch nicht fest anziehen.



Sold separately / Vendus séparément / vendido en las opciones /
옵션 판매 / Optional erhältlich

S X 12 (+2)

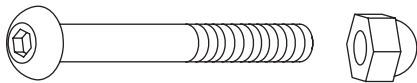

T X 80 (+8)

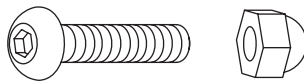

U X 21 (+3)

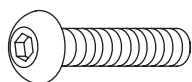

V X 228 (+10)

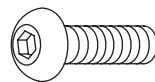

X X 16 (+2)



X1 X 8 (+2)

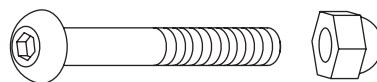

Y X 24 (+5)

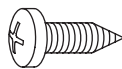

W2 X 1

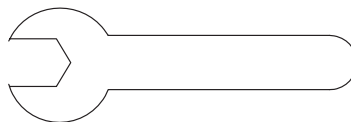

Wa X 2

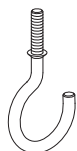

Z X 1

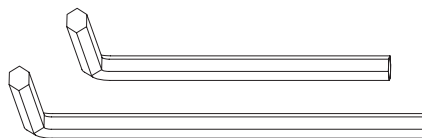

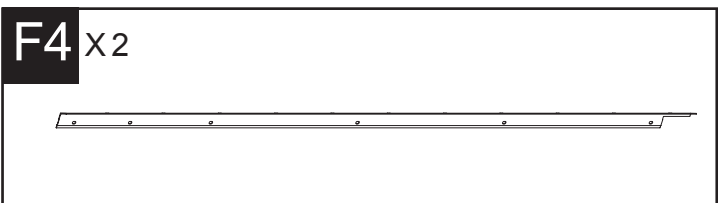
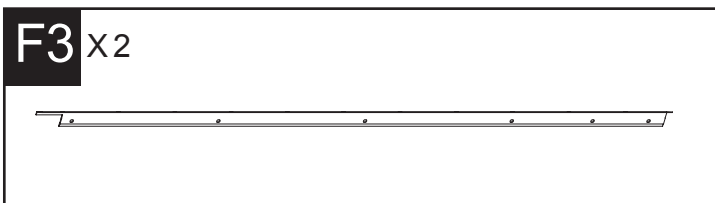
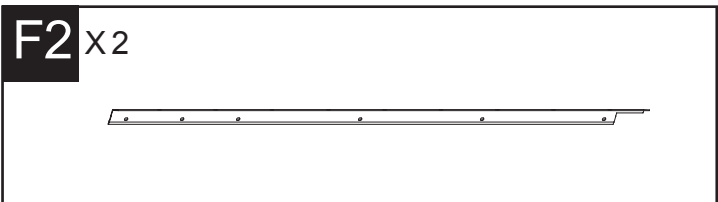
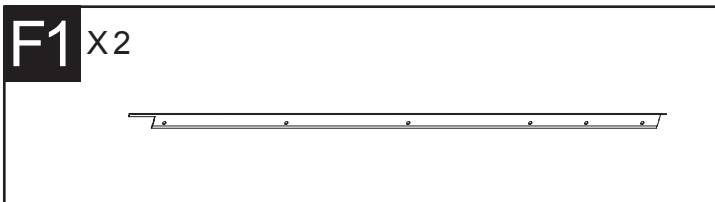
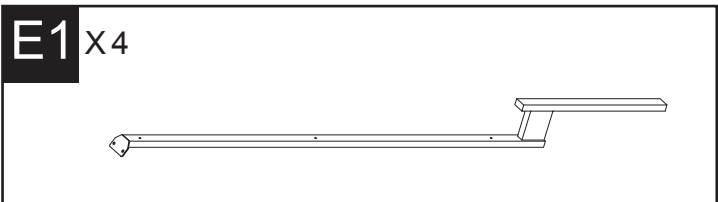
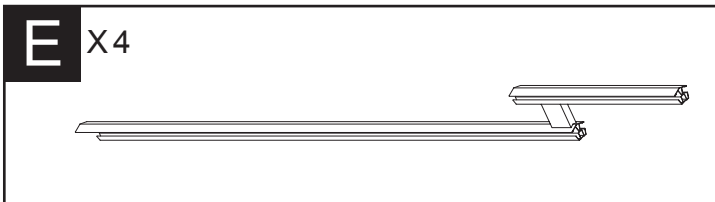
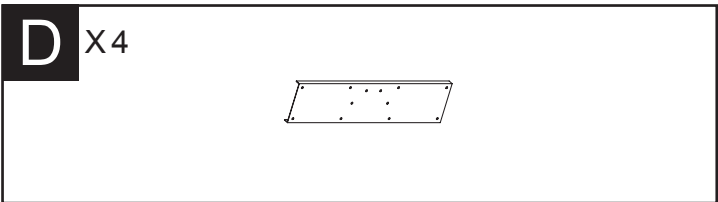
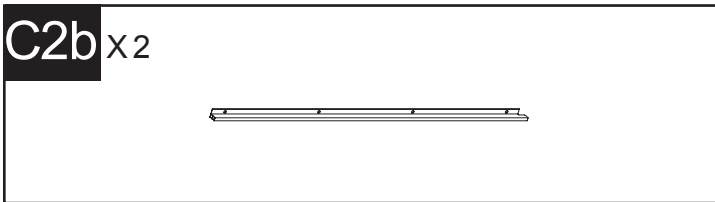
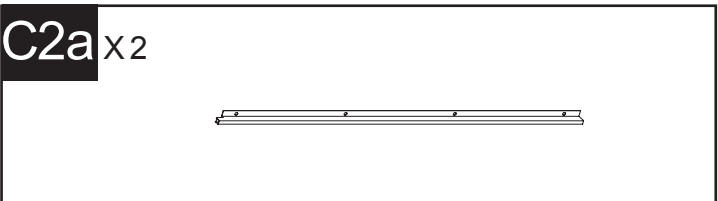
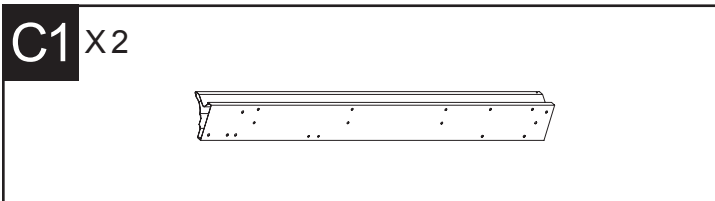
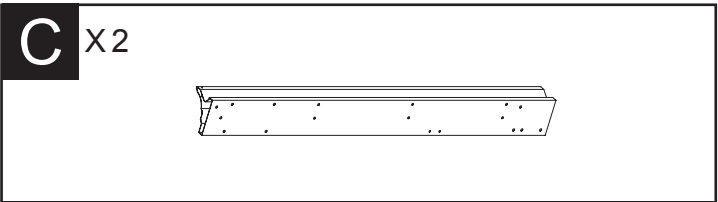
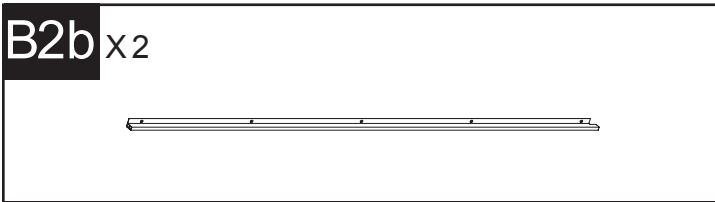
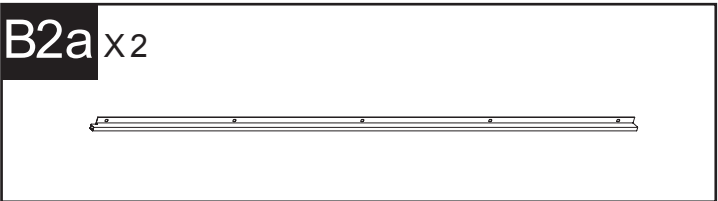
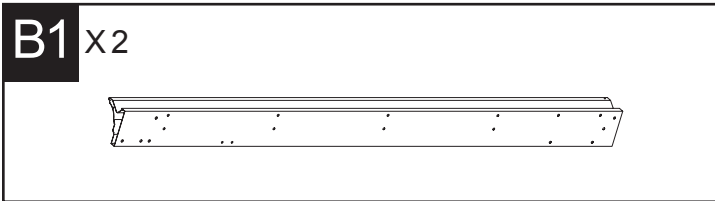
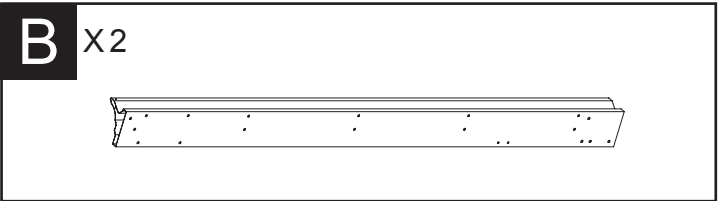
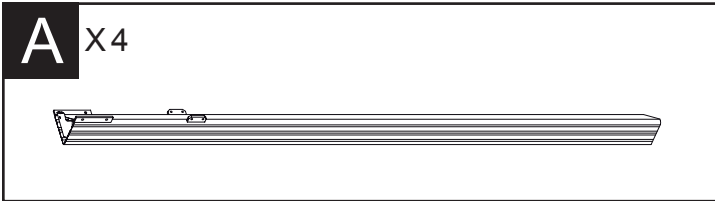

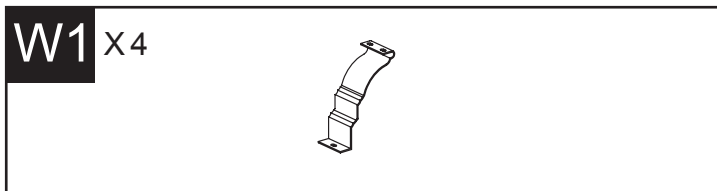
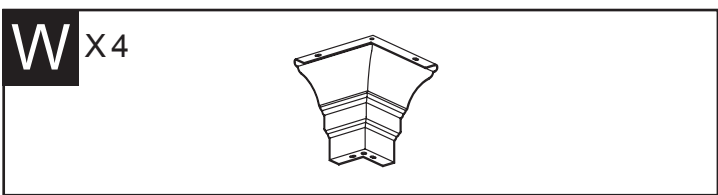
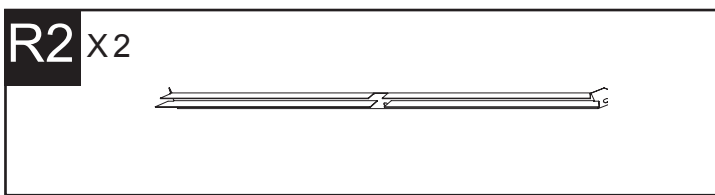
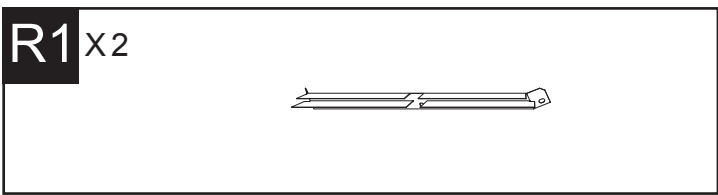
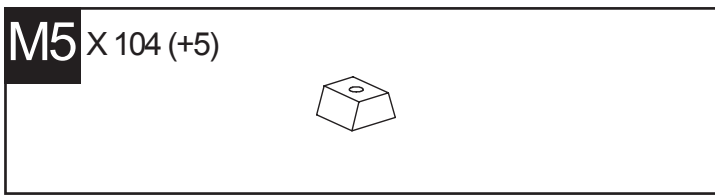
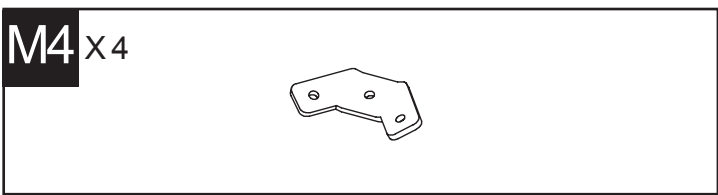
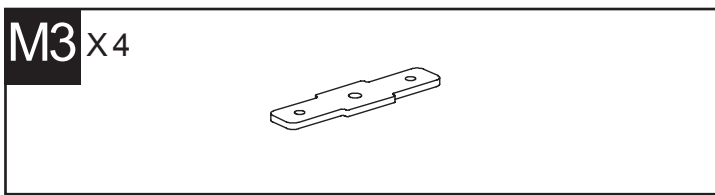
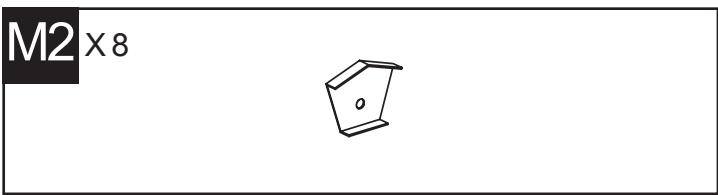
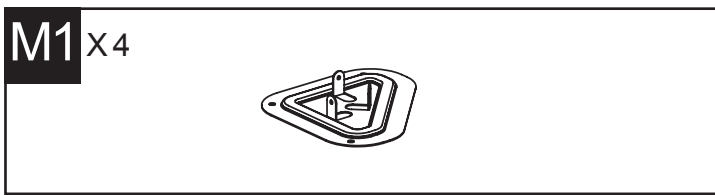
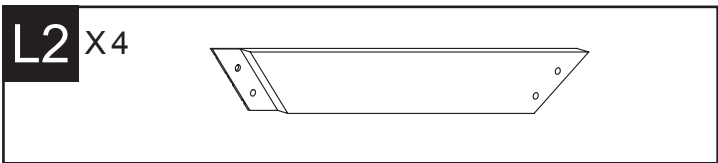
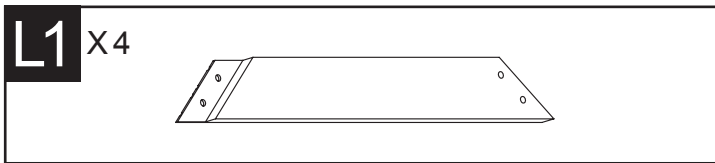
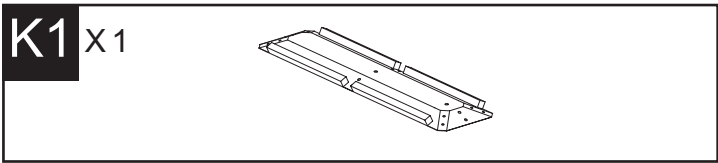
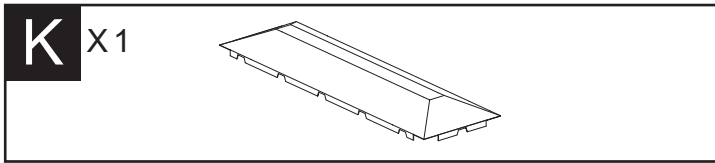
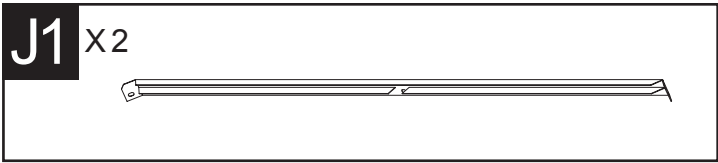
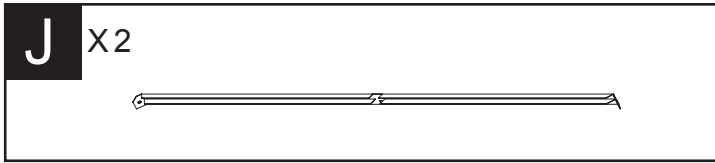
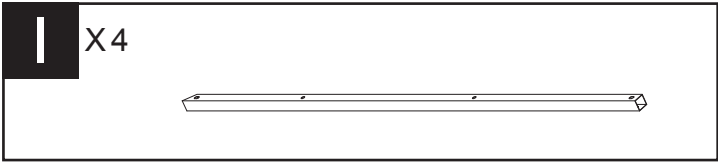
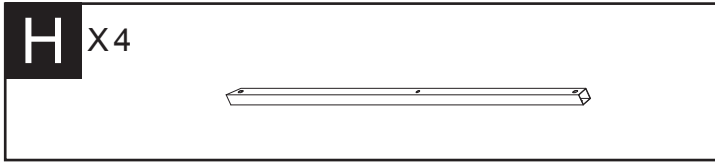

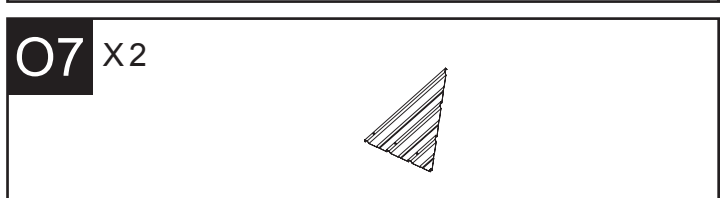
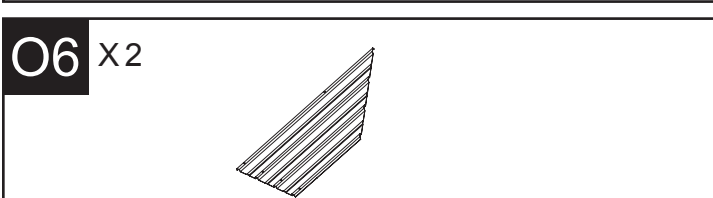
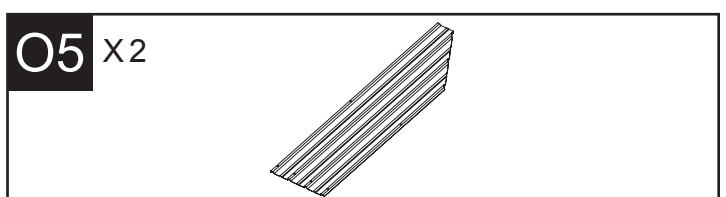
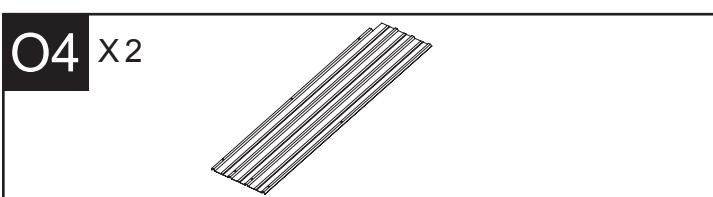
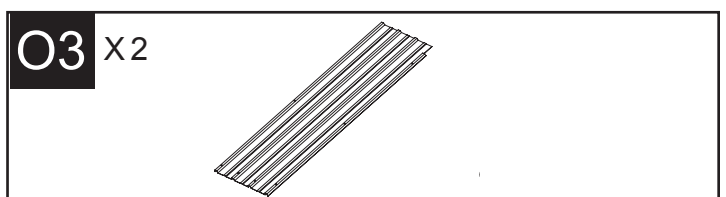
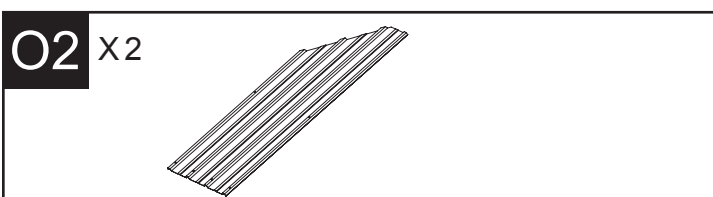
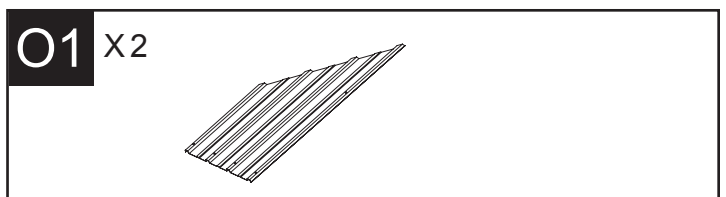
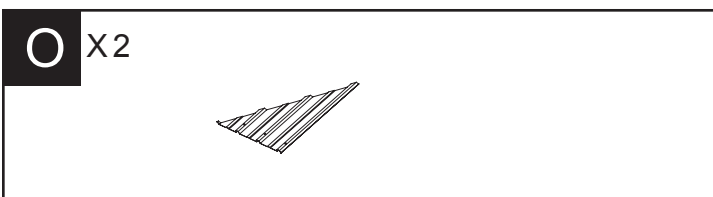
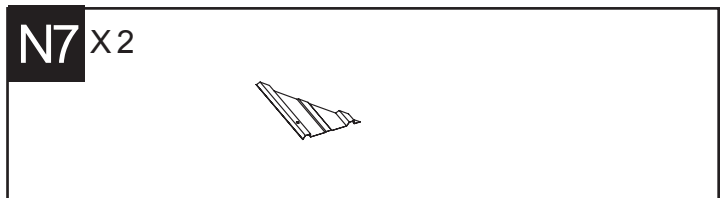
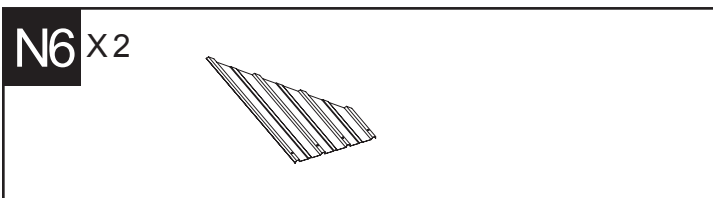
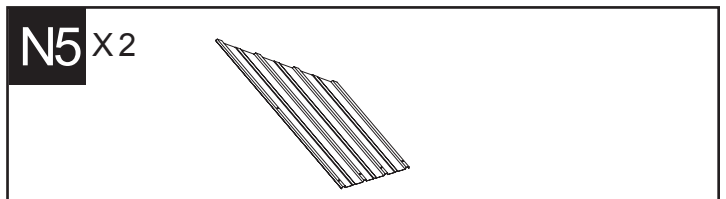
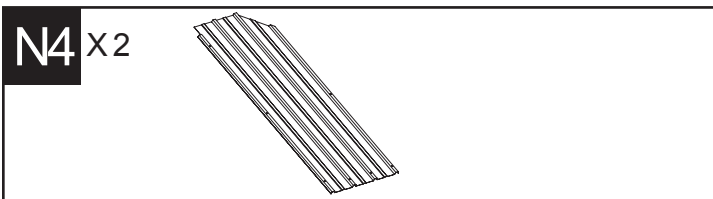
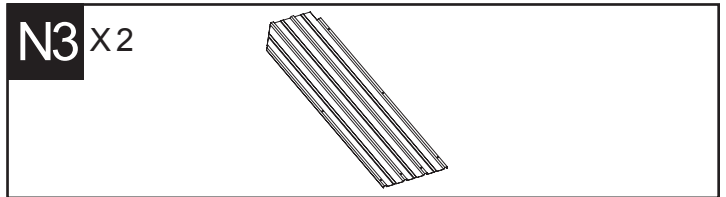
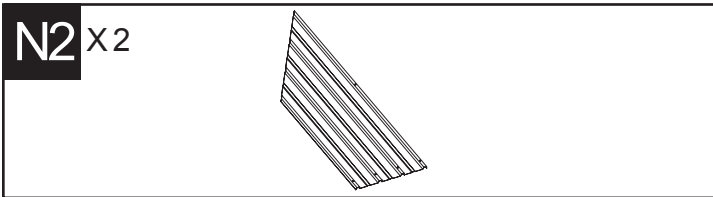
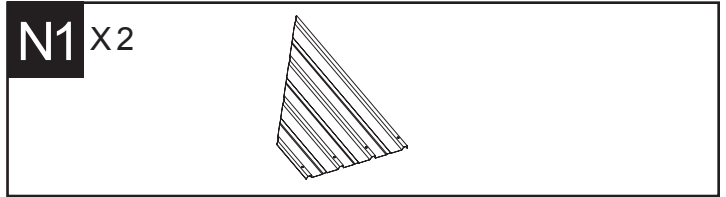
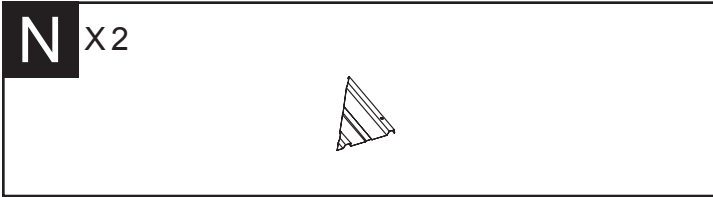

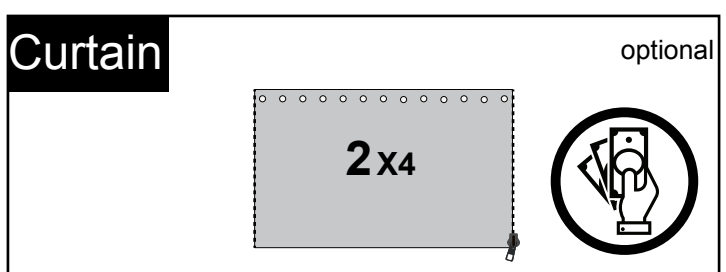
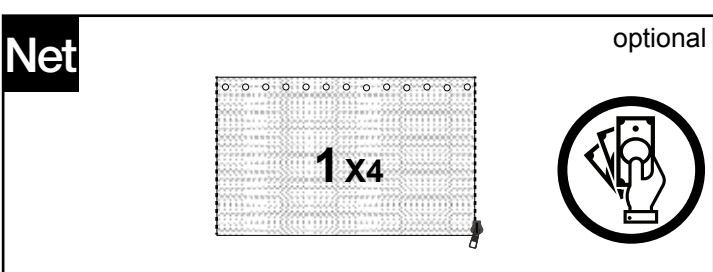
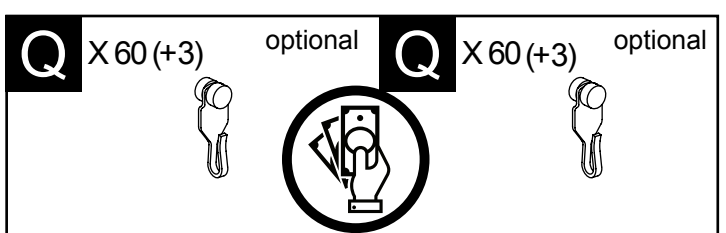
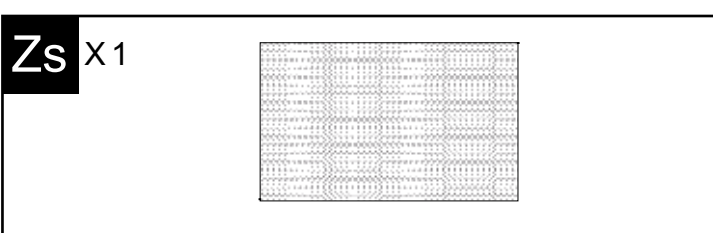
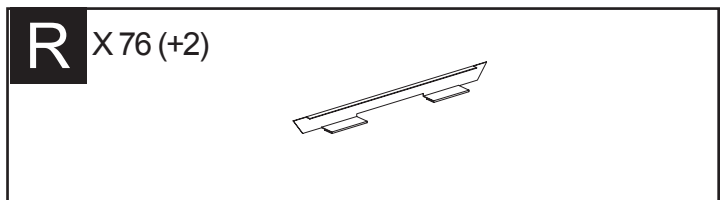
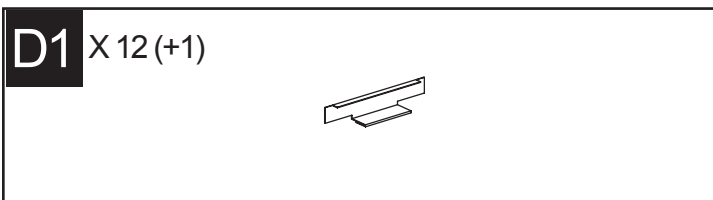
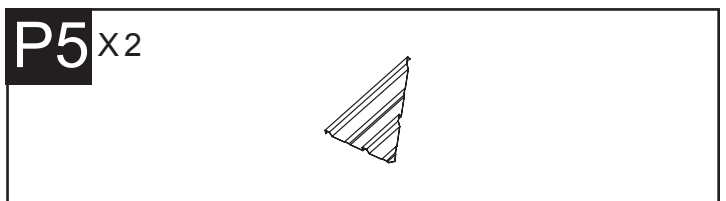
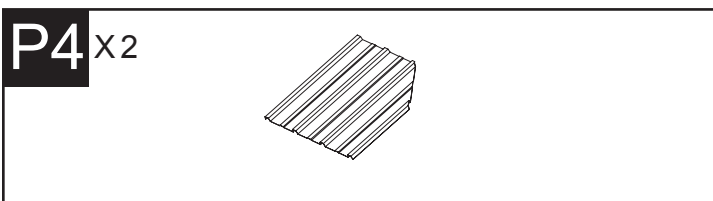
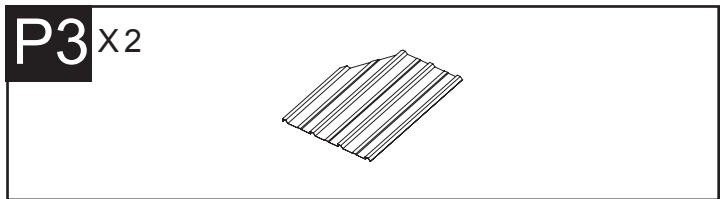
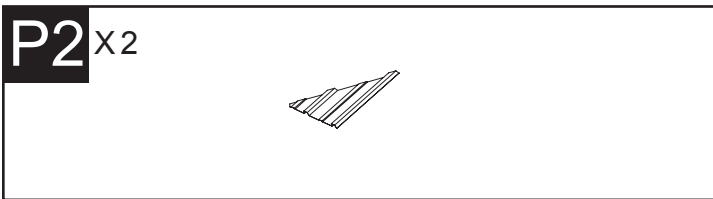
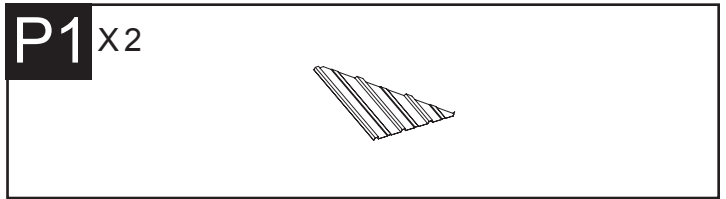
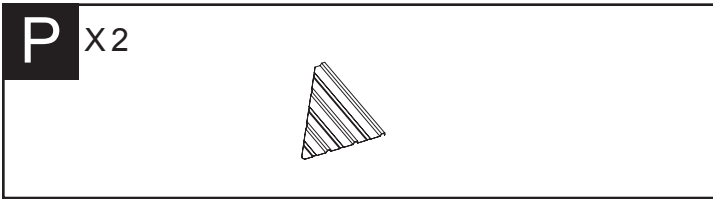

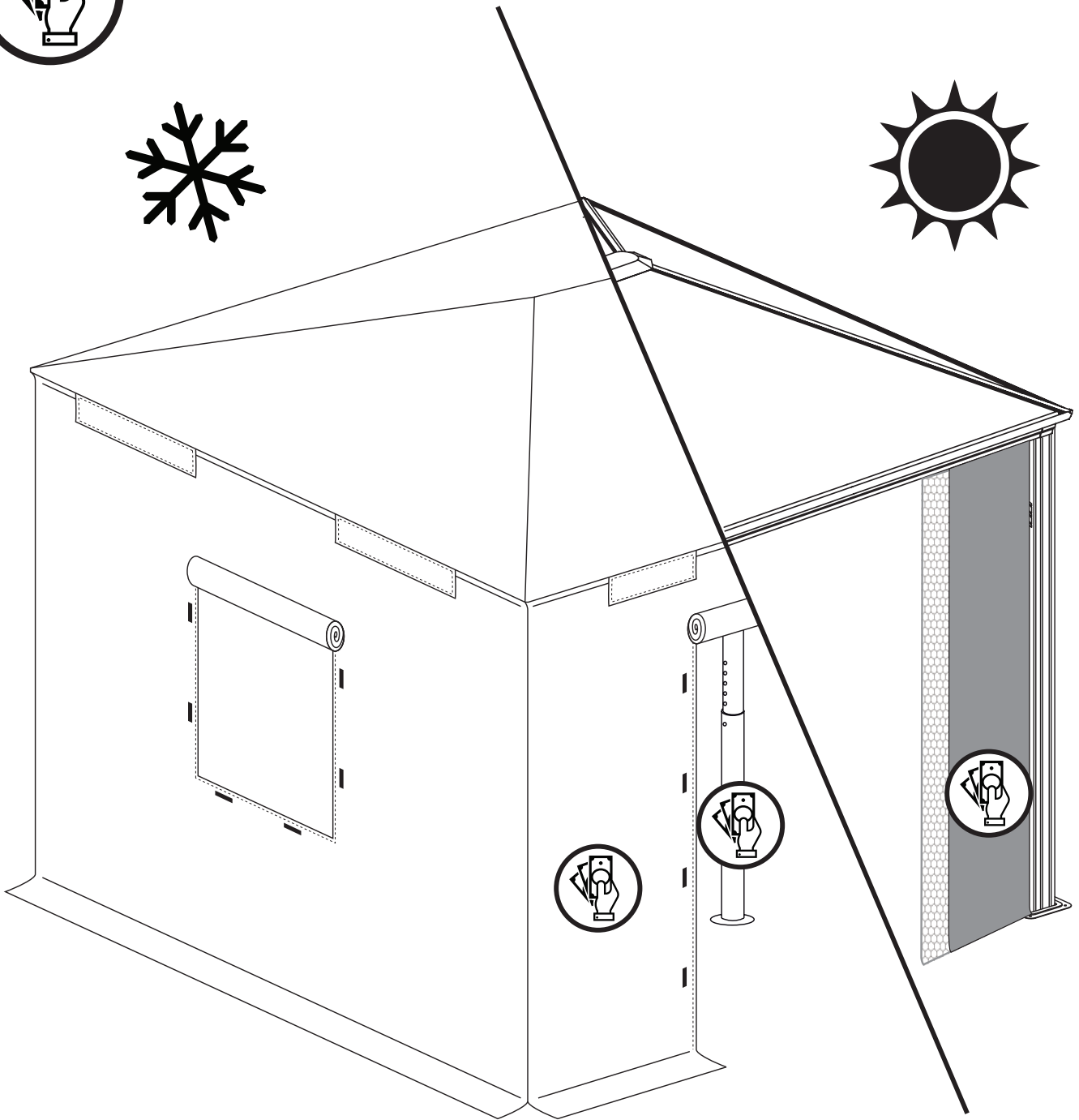
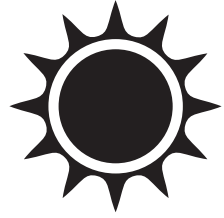

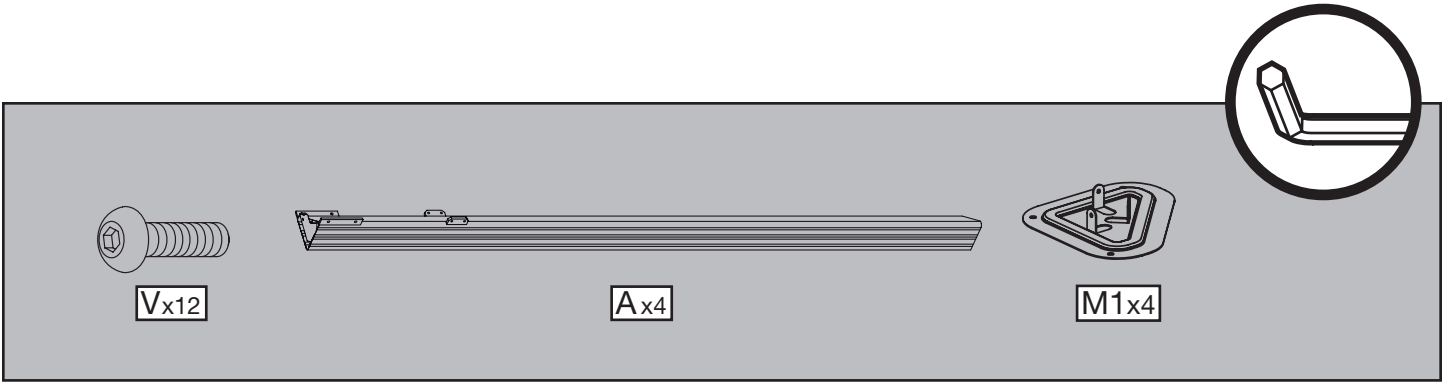
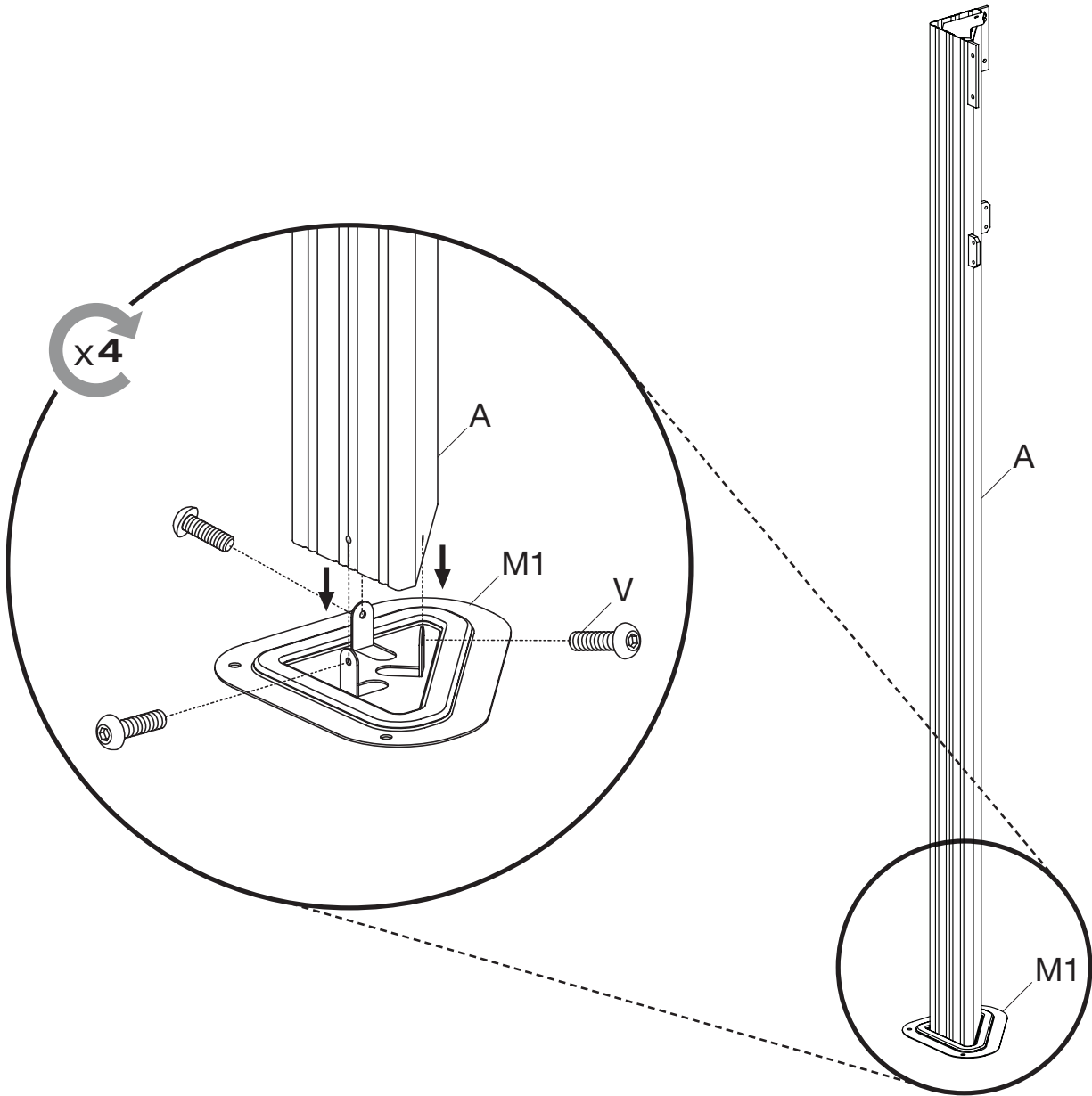

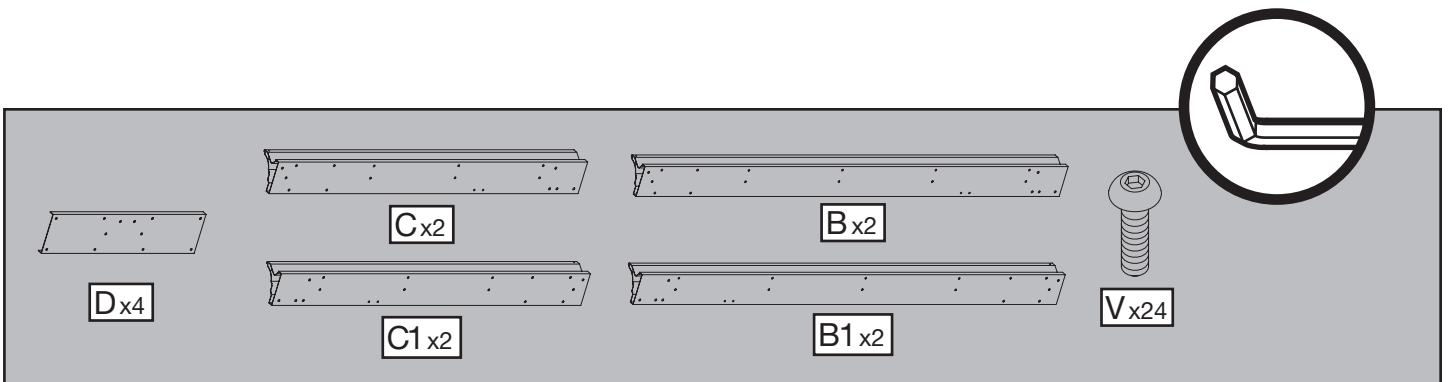
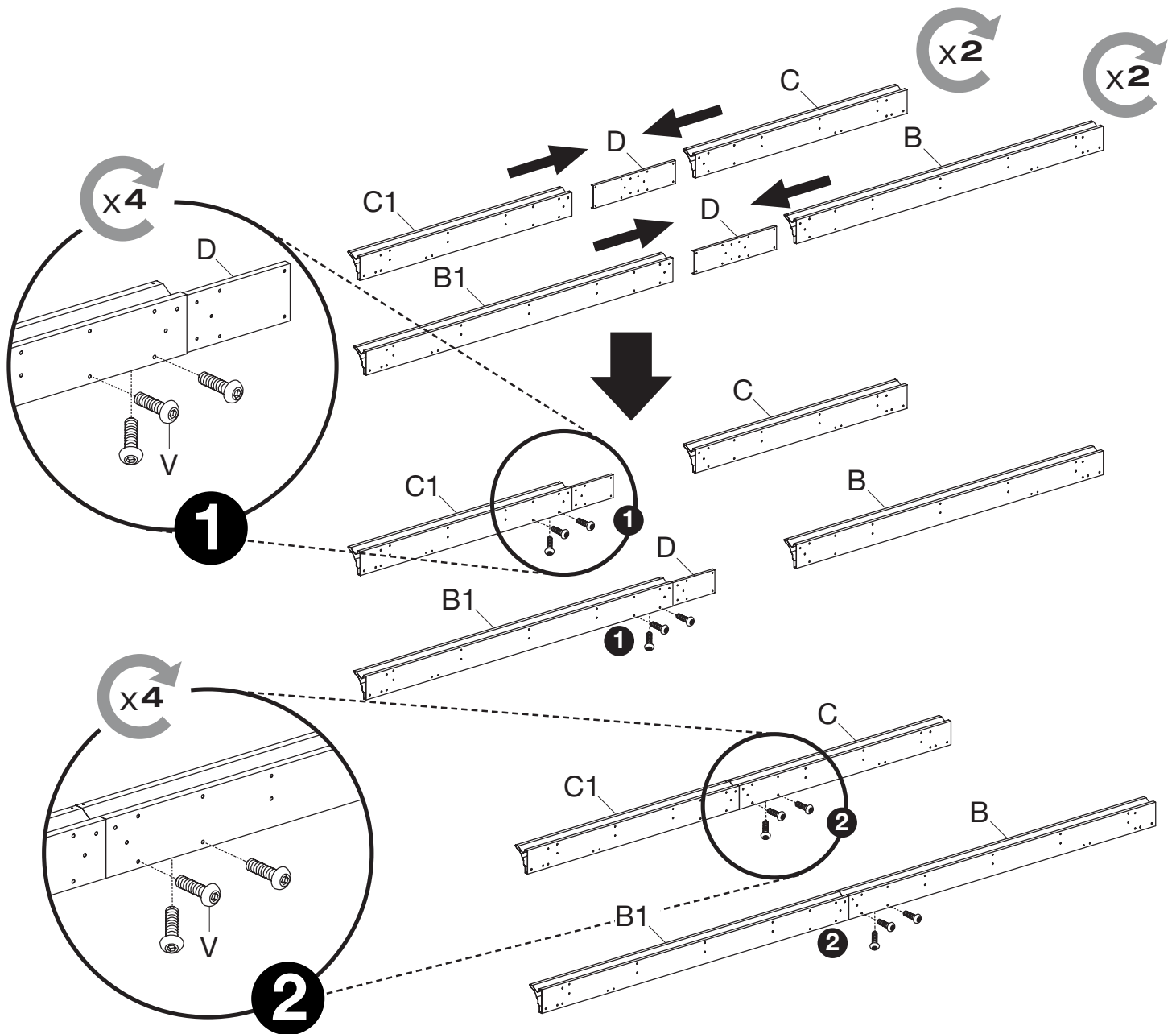

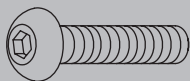
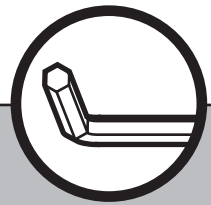
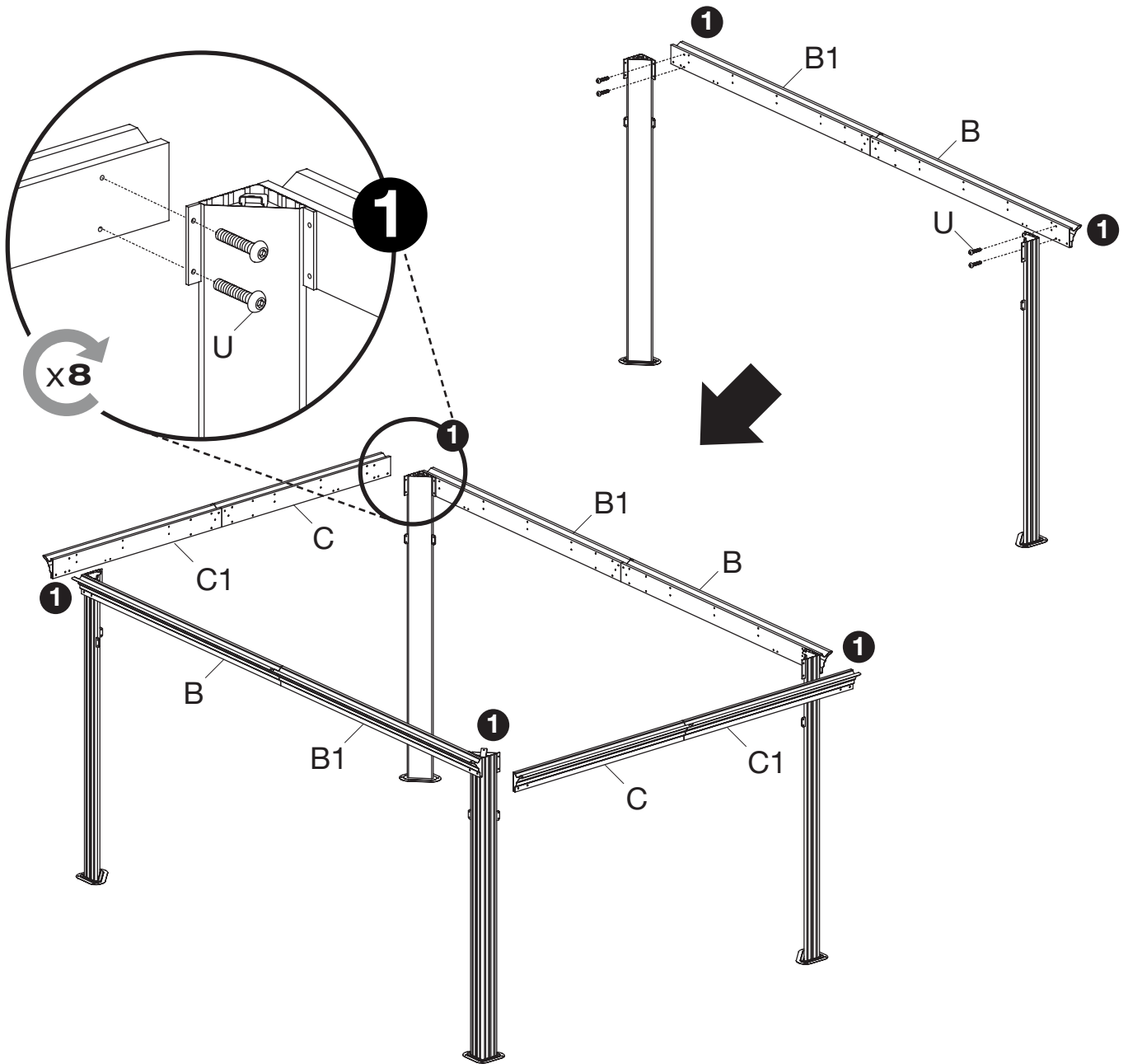

U x16

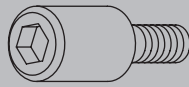
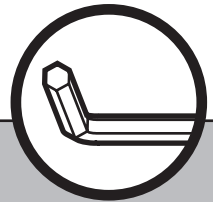
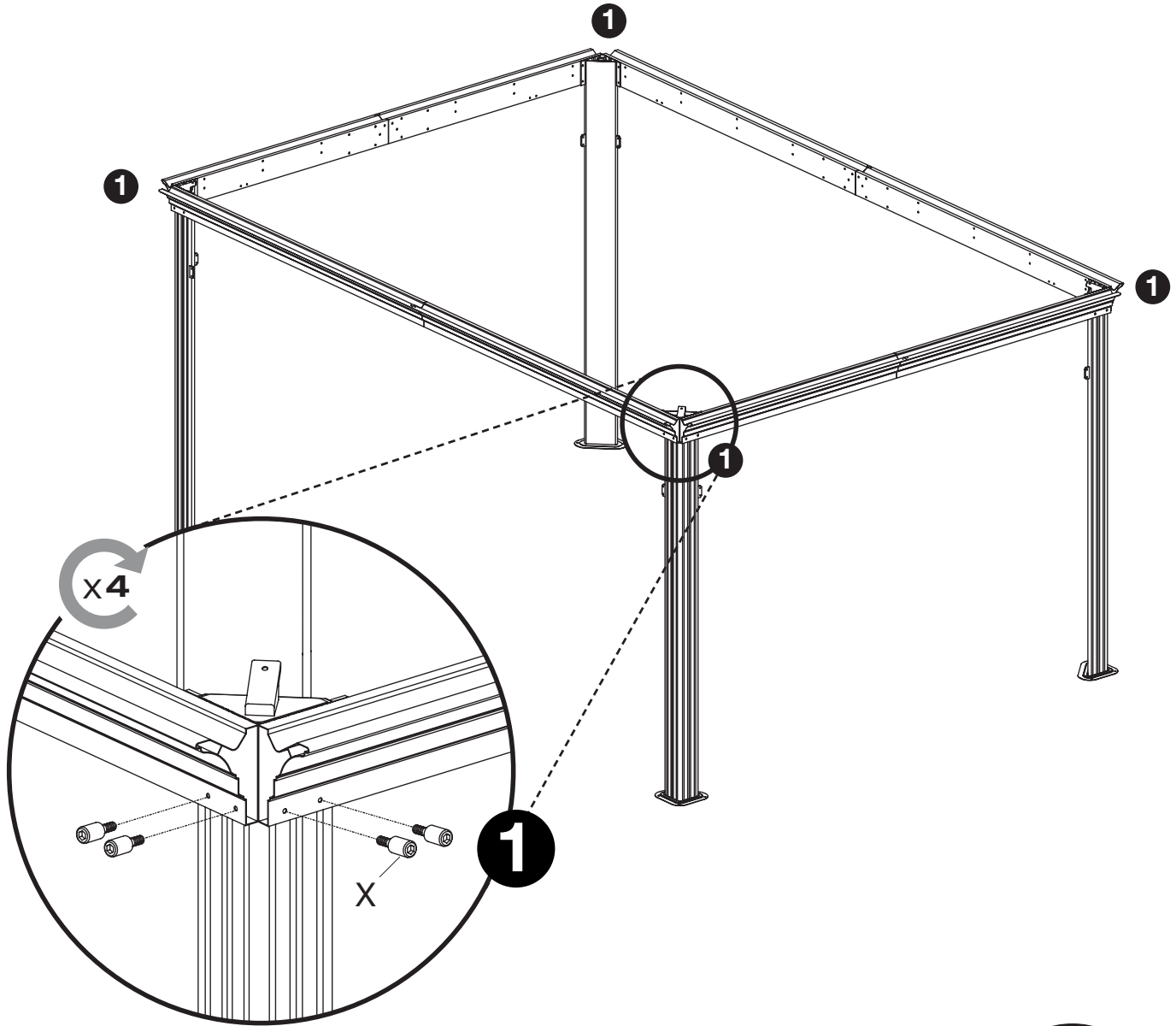

Xx16

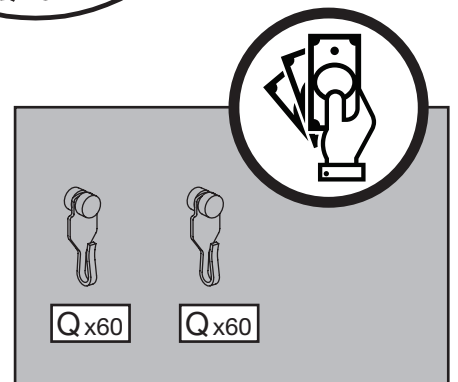
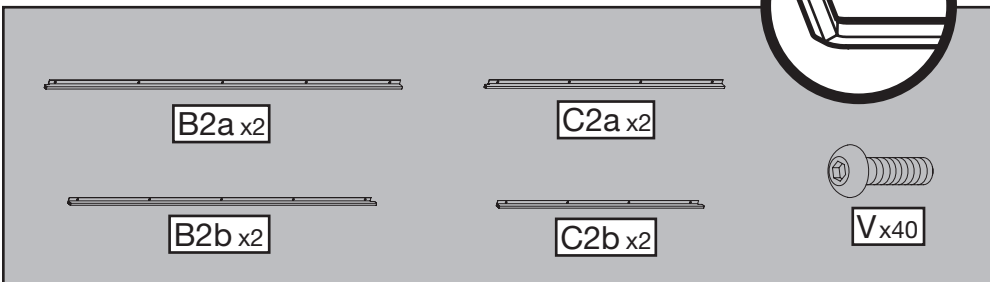
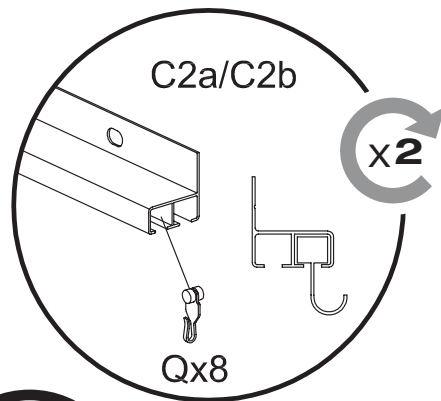
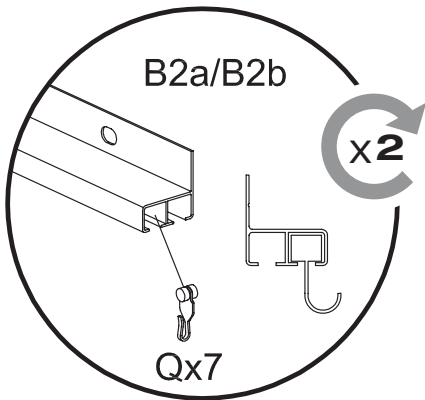
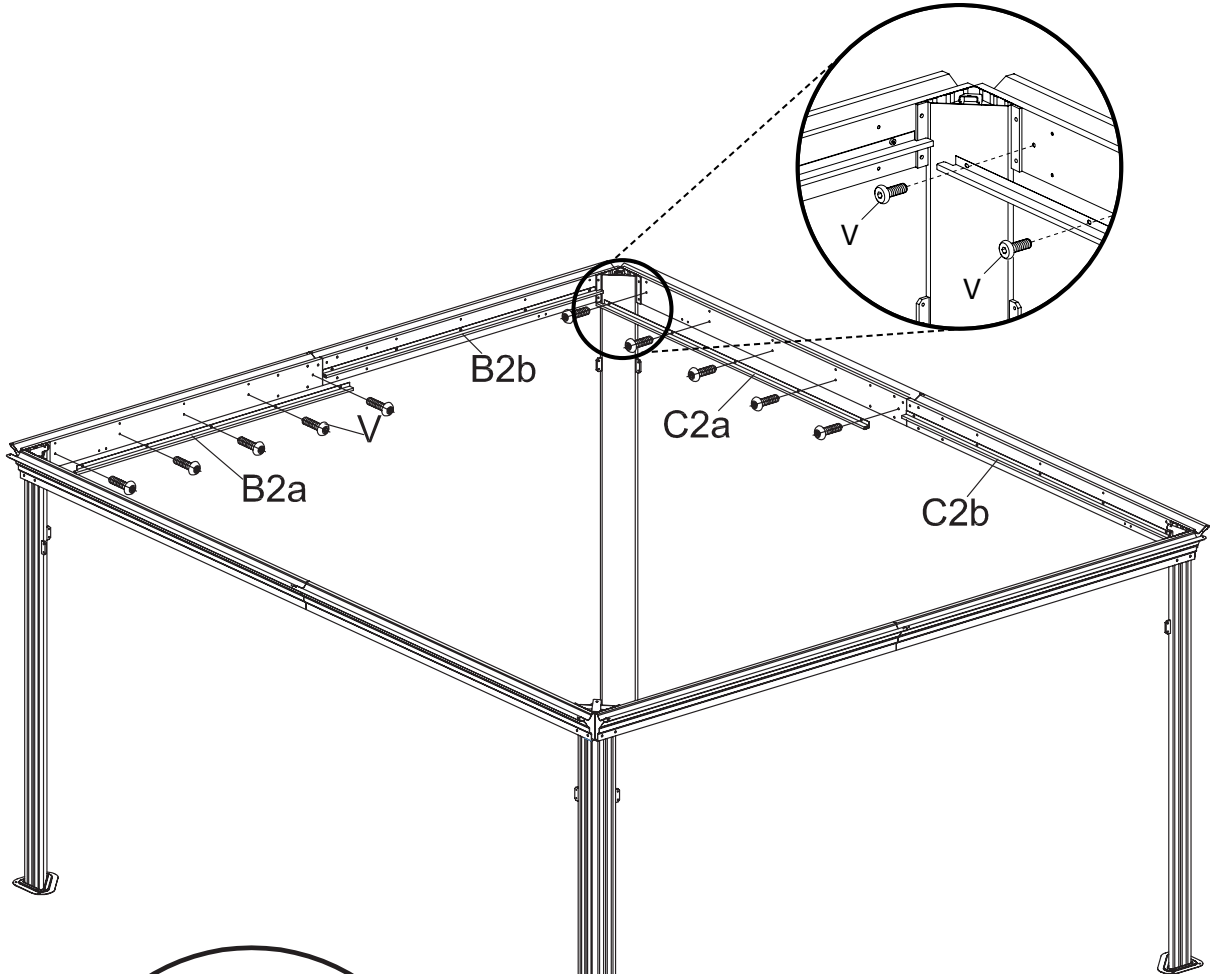

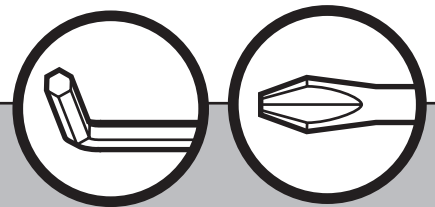
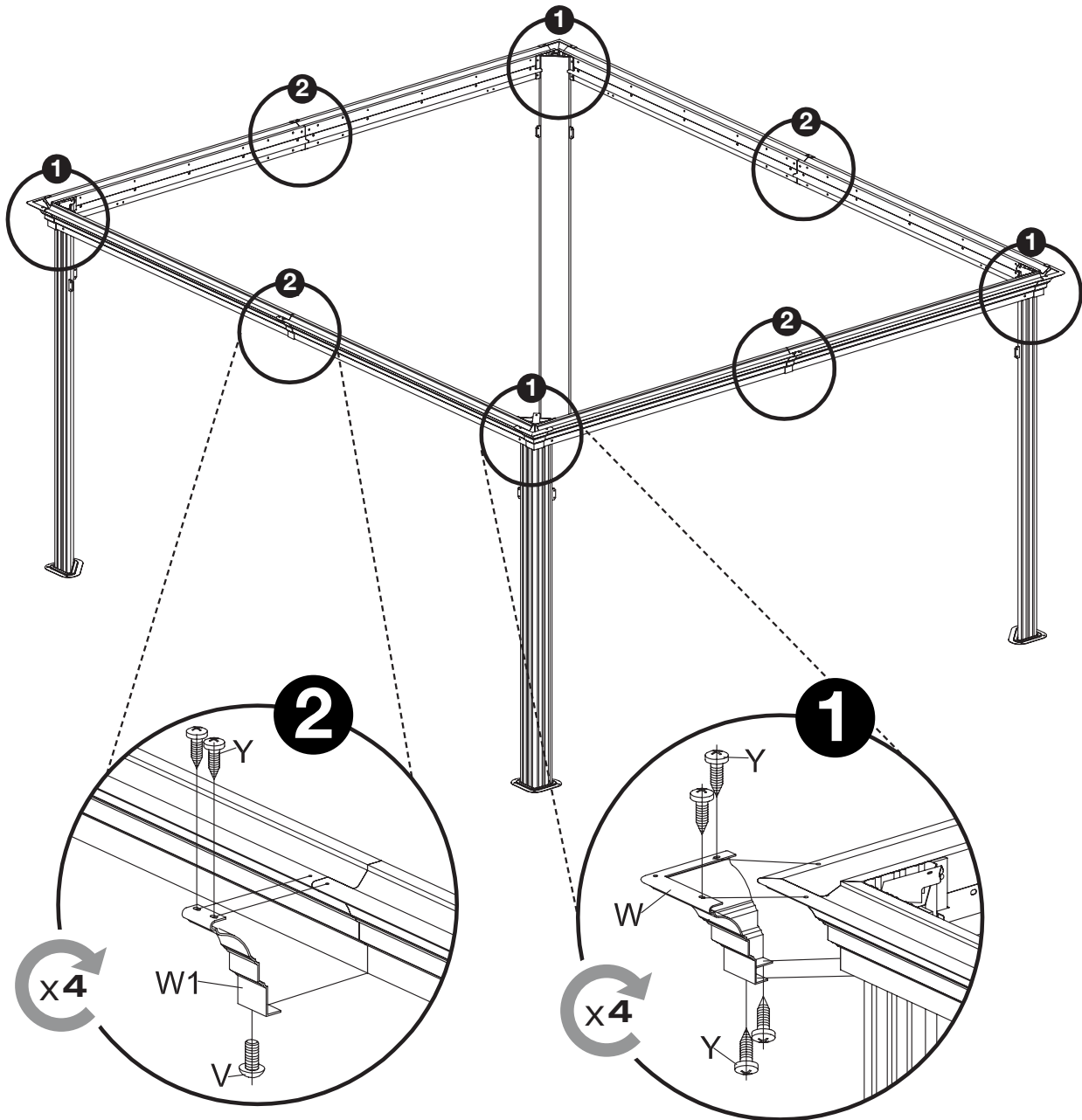

W_{x4}

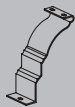

W1_{x4}

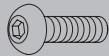

V_{x4}



Y_{x24}

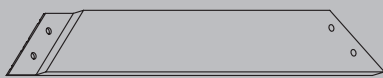
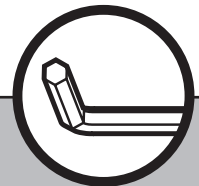
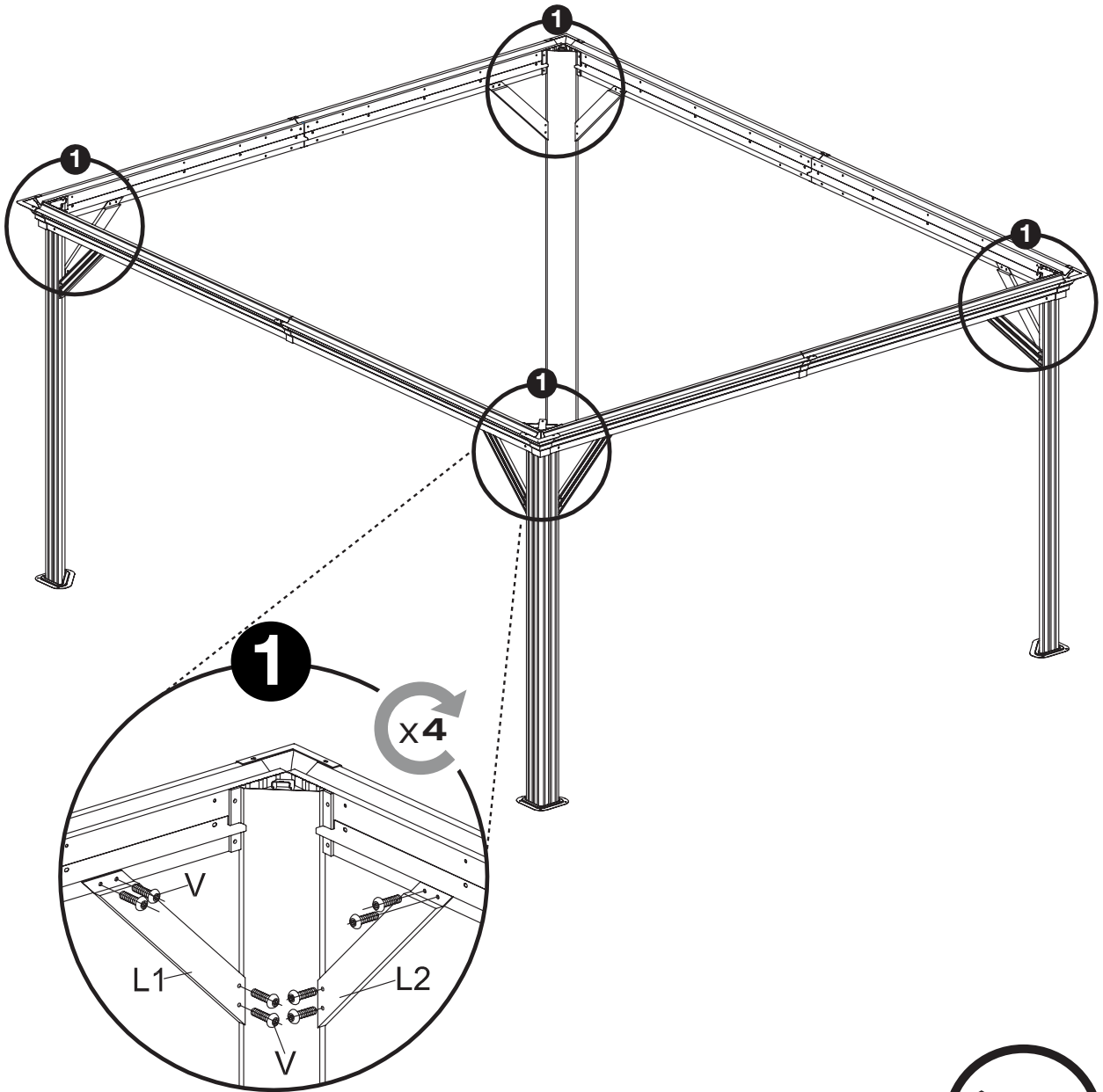

L1x4

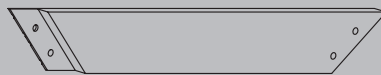

L2x4

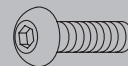

Vx32

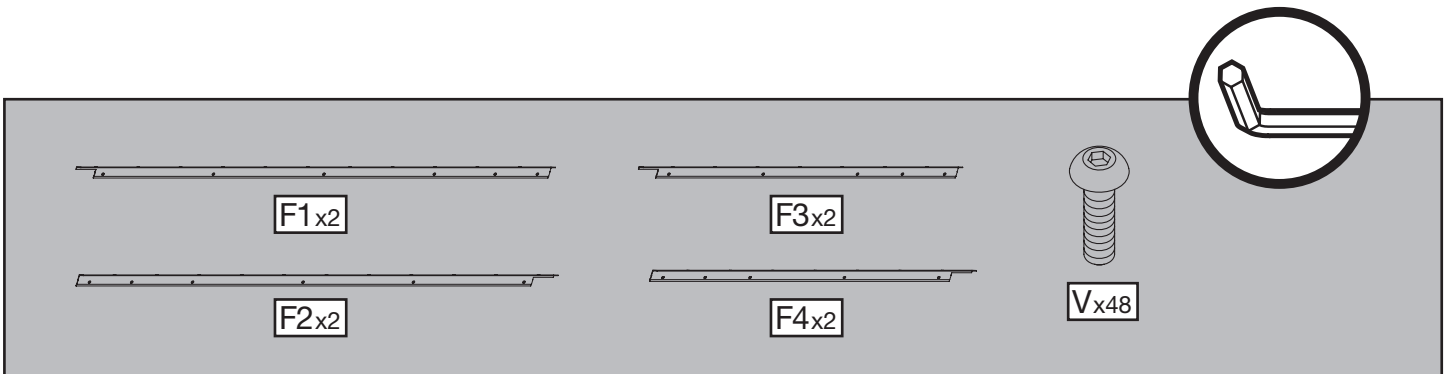
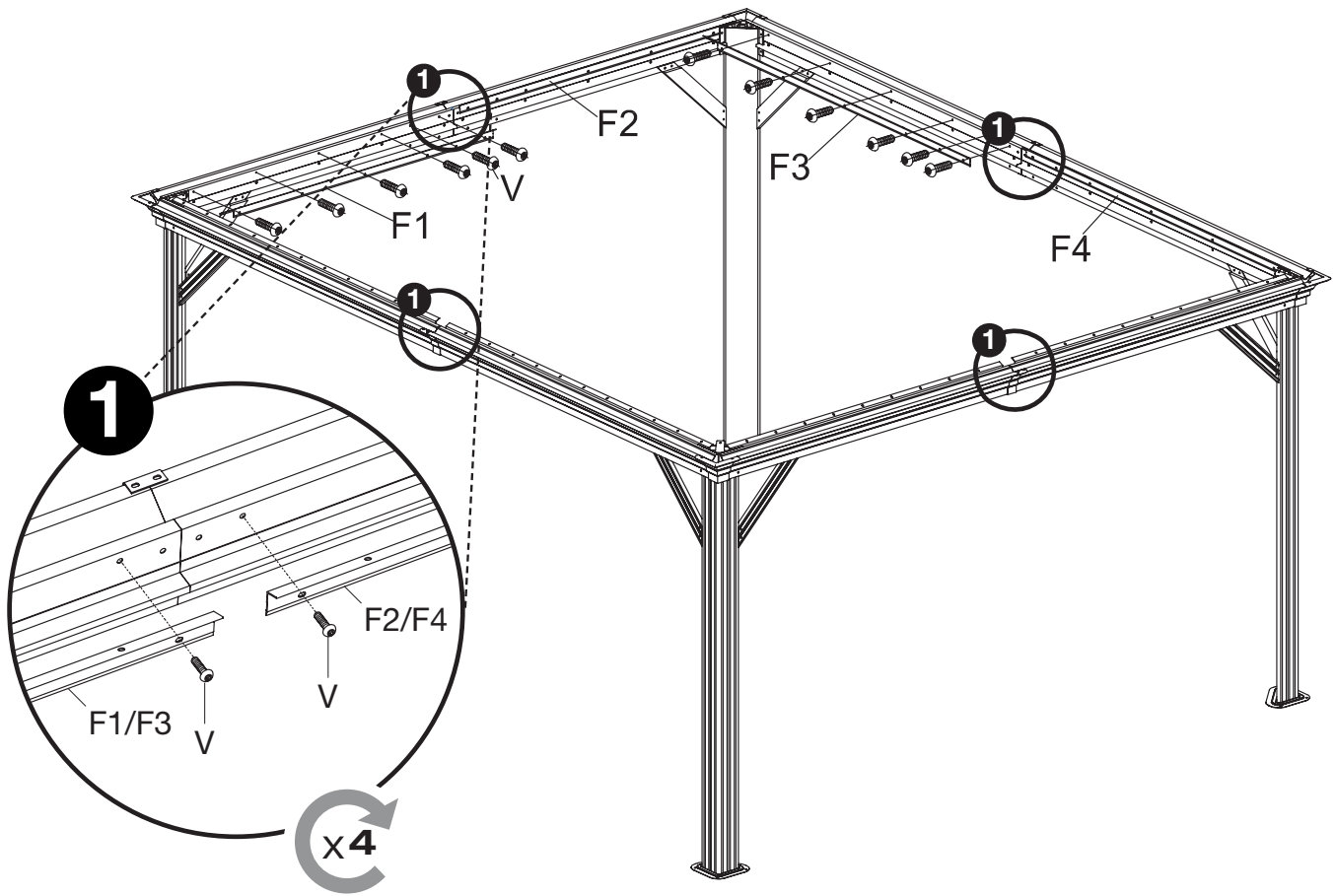

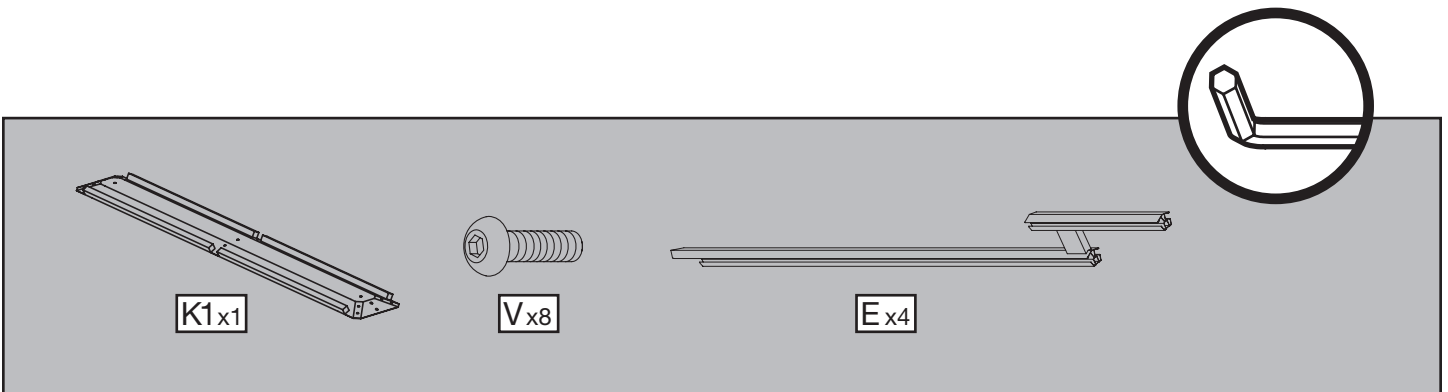
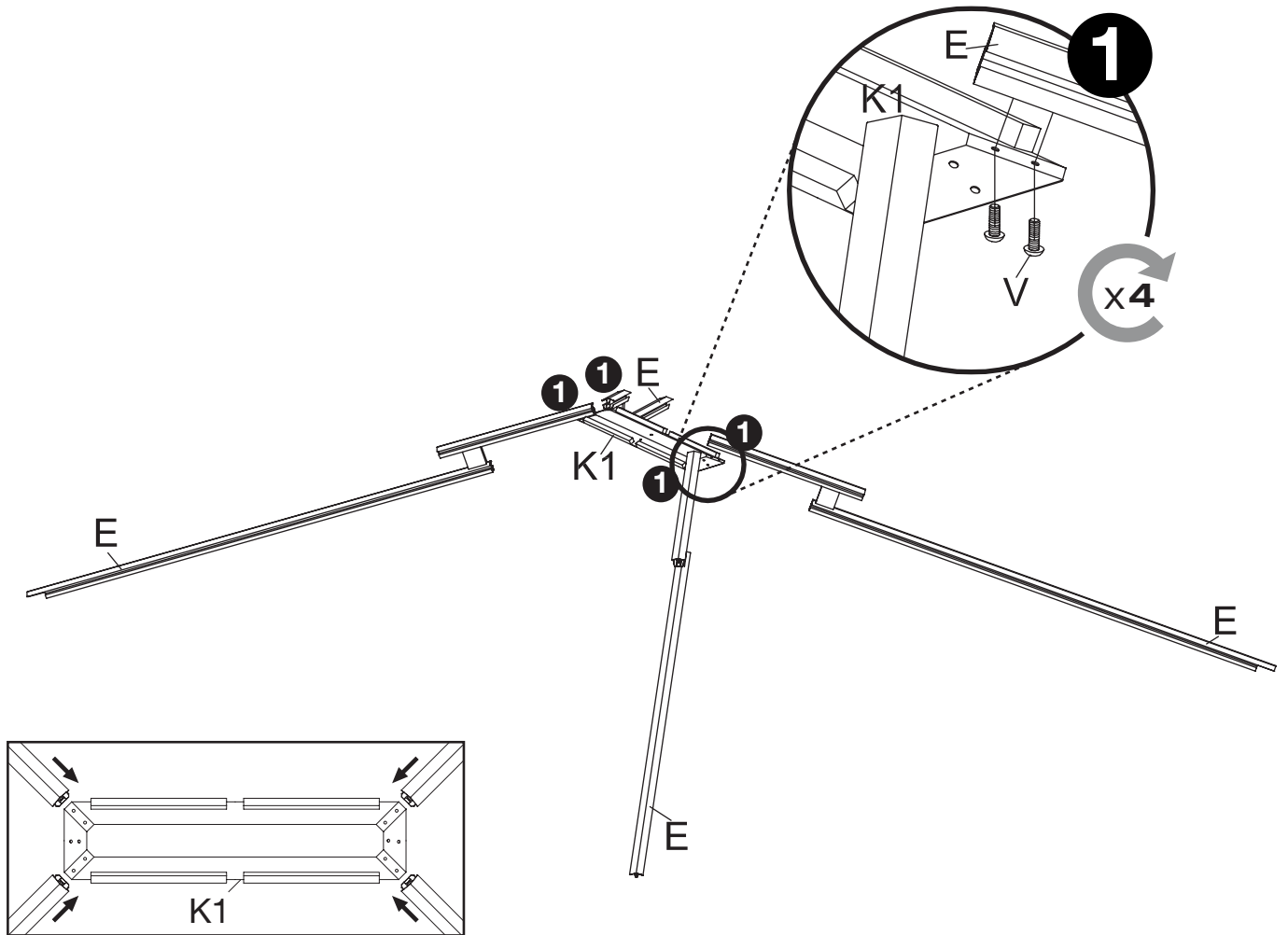

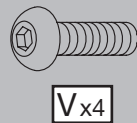
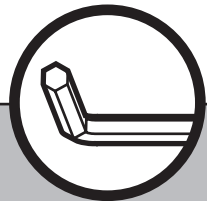
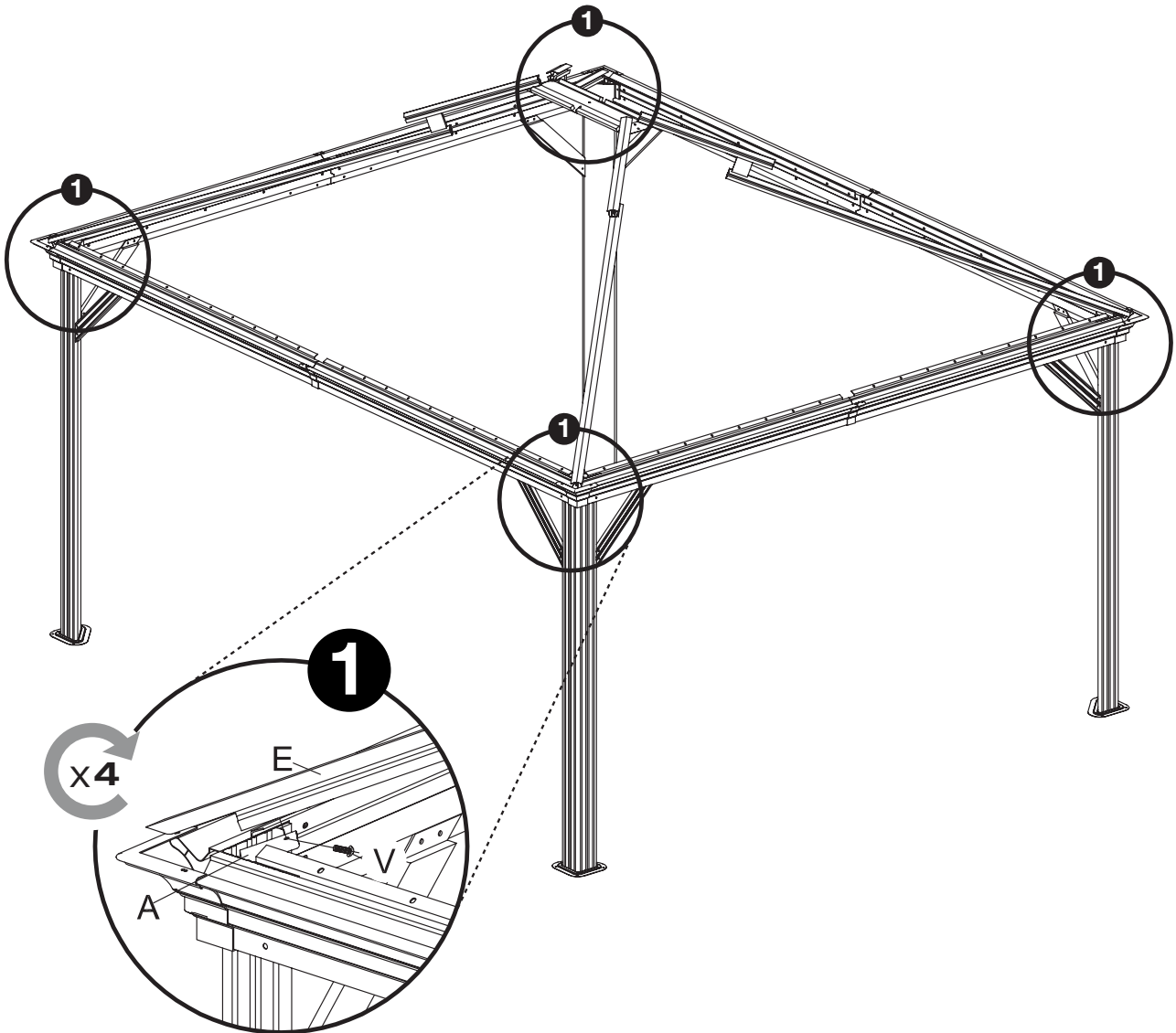

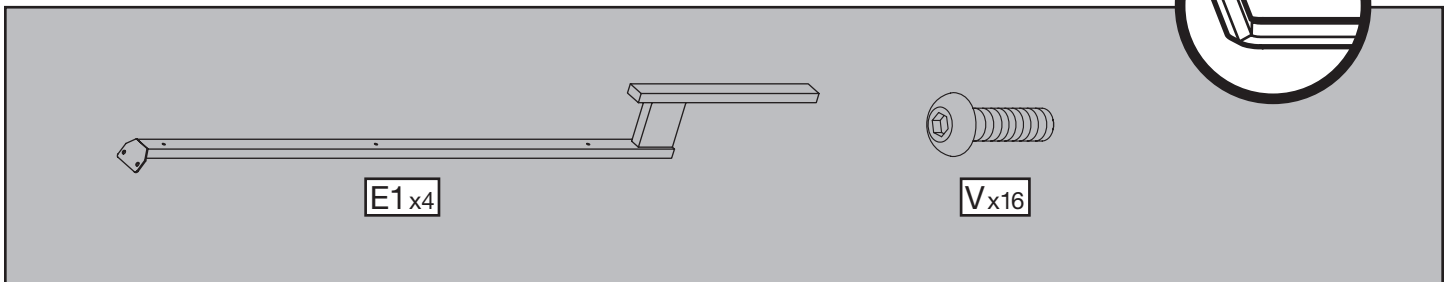
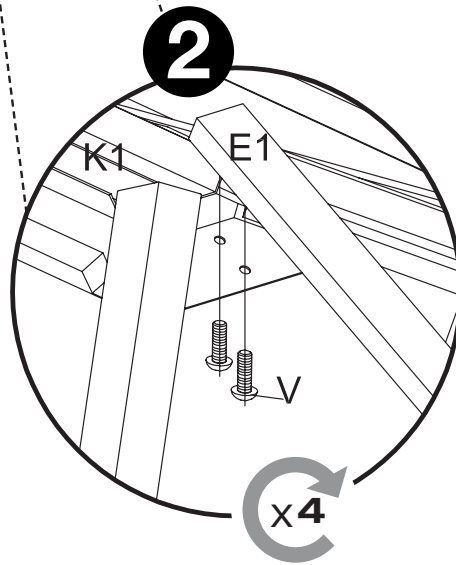
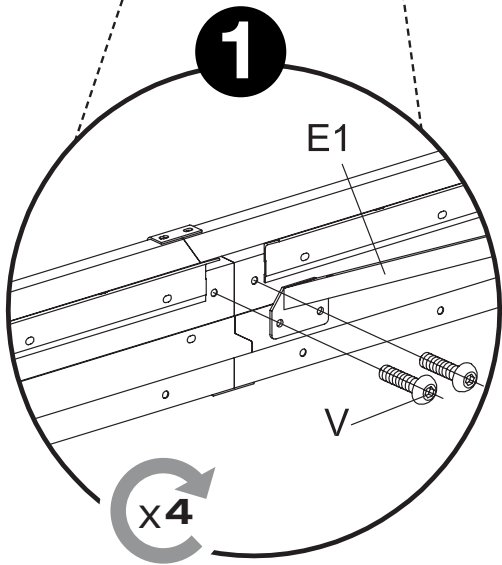
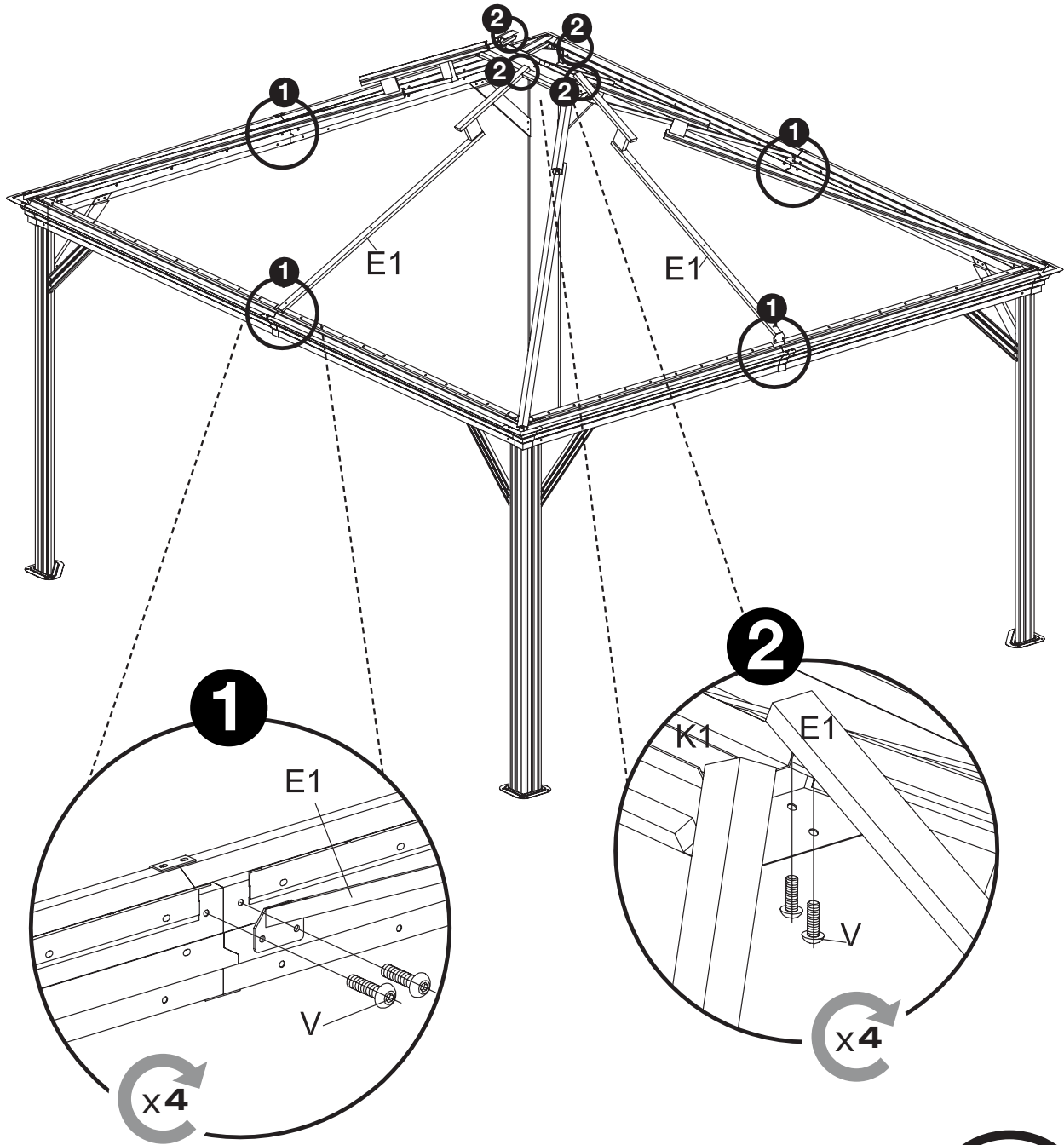

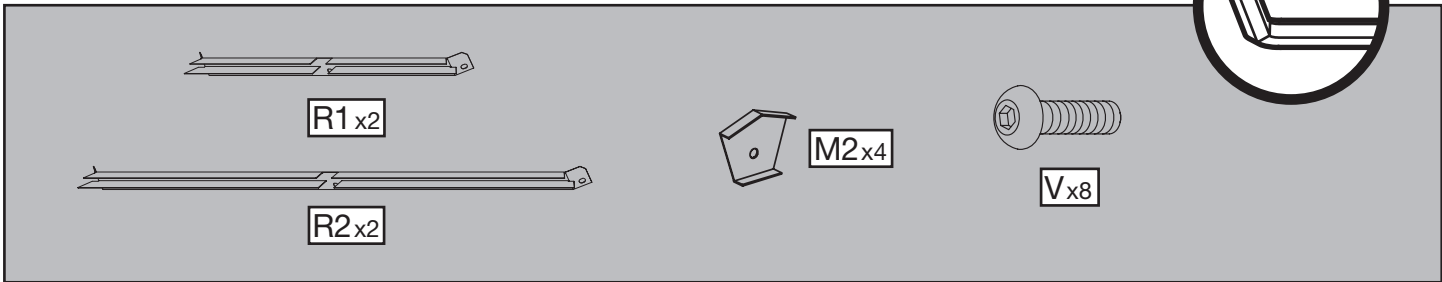
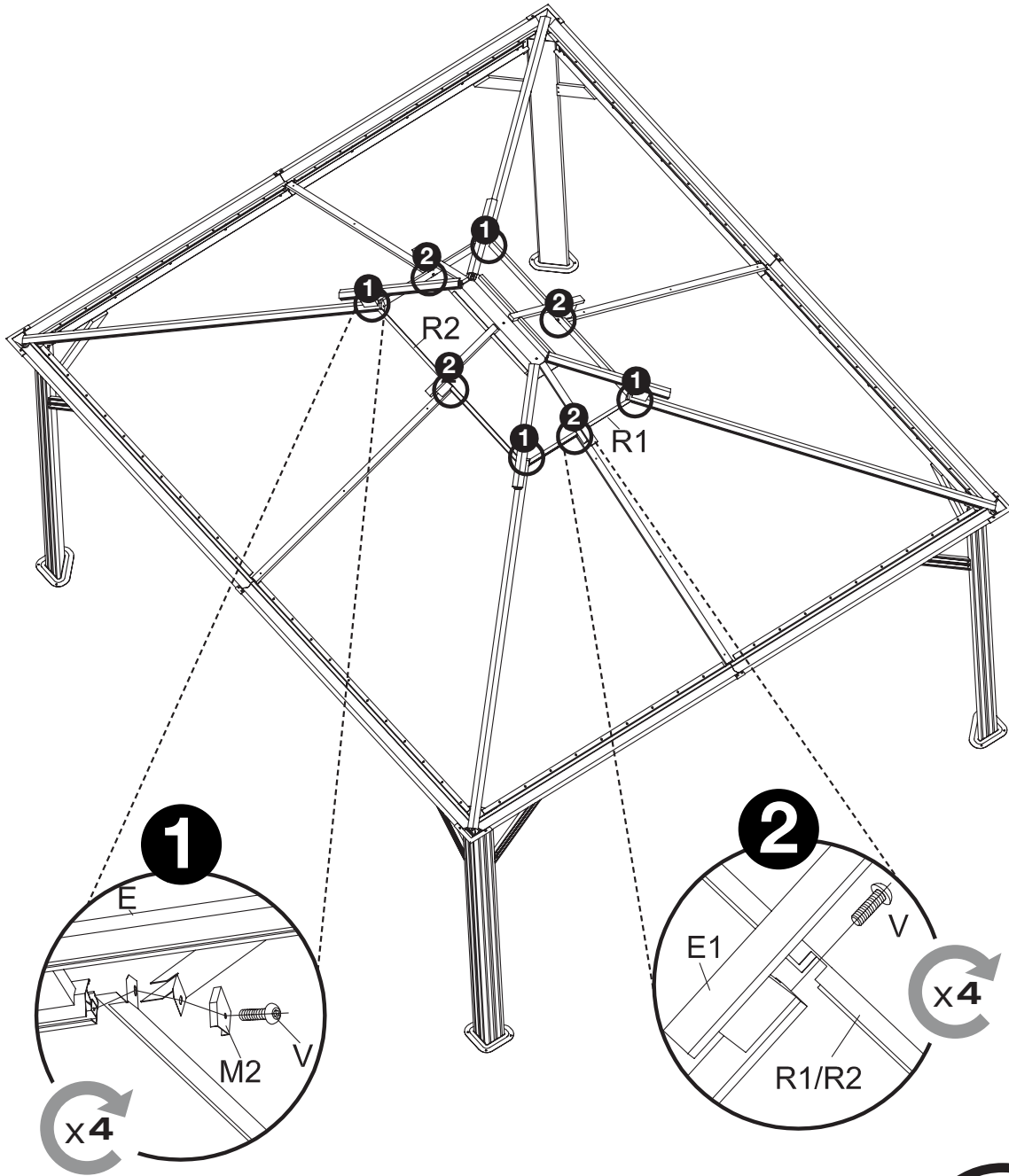

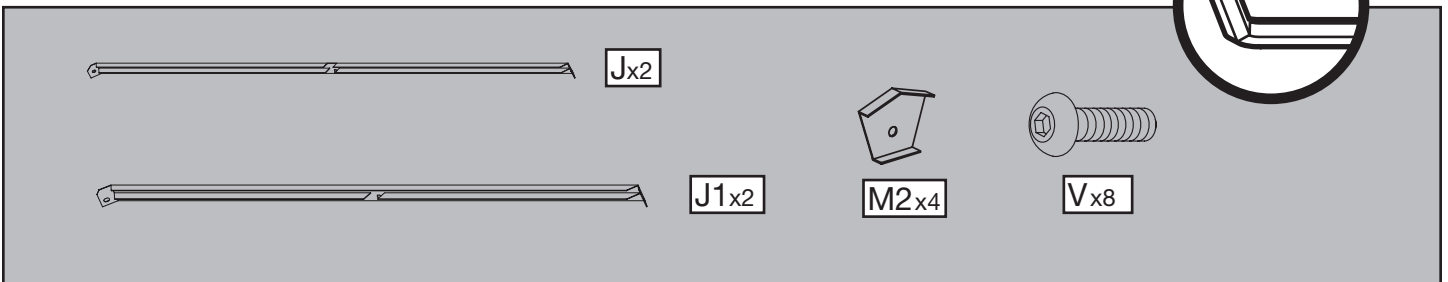
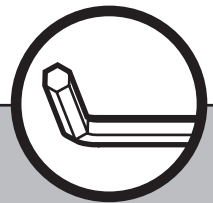
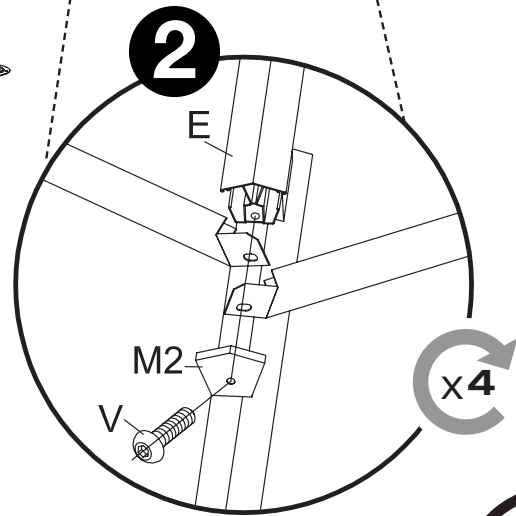
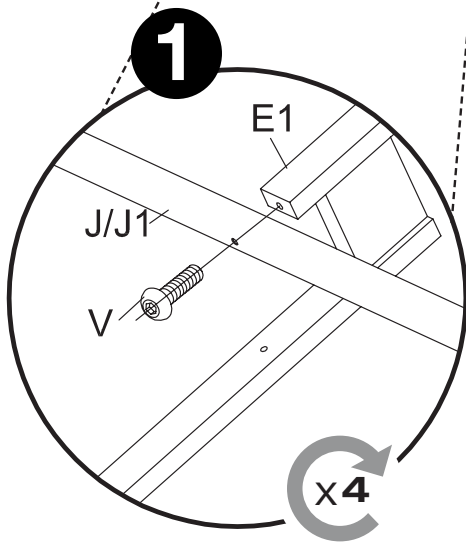
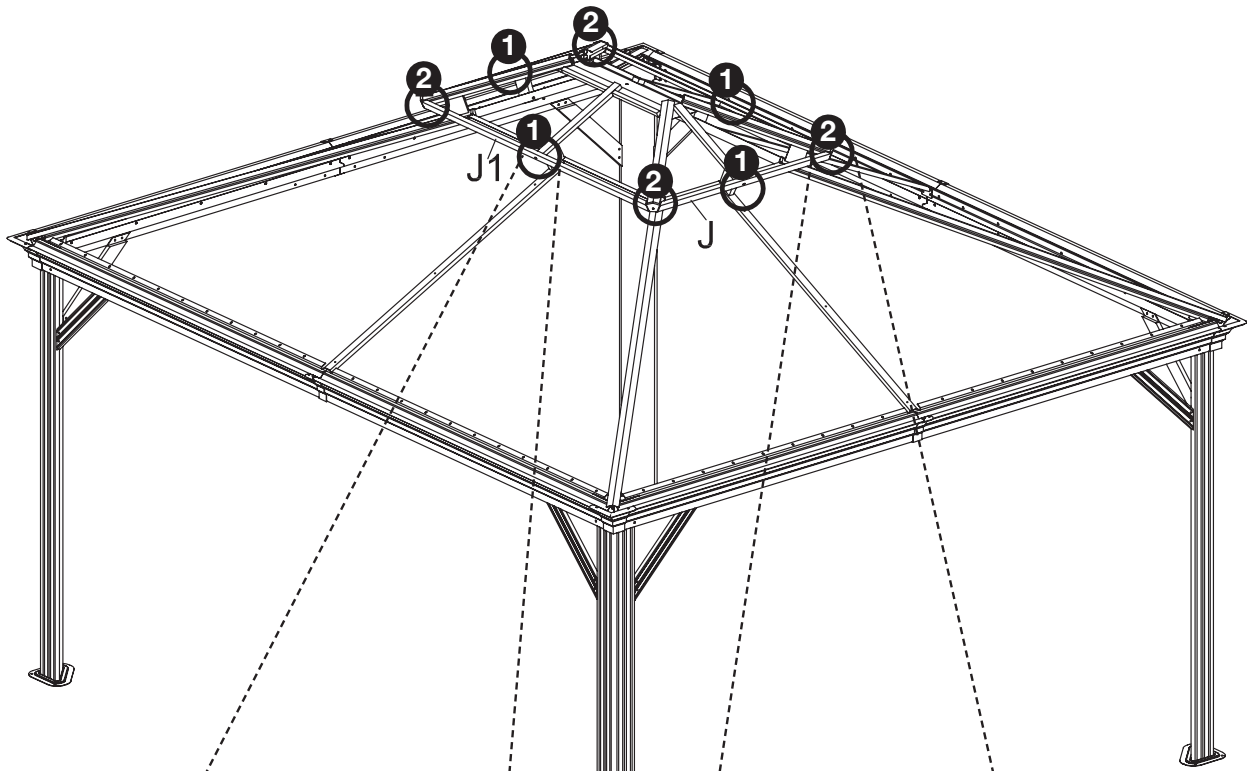

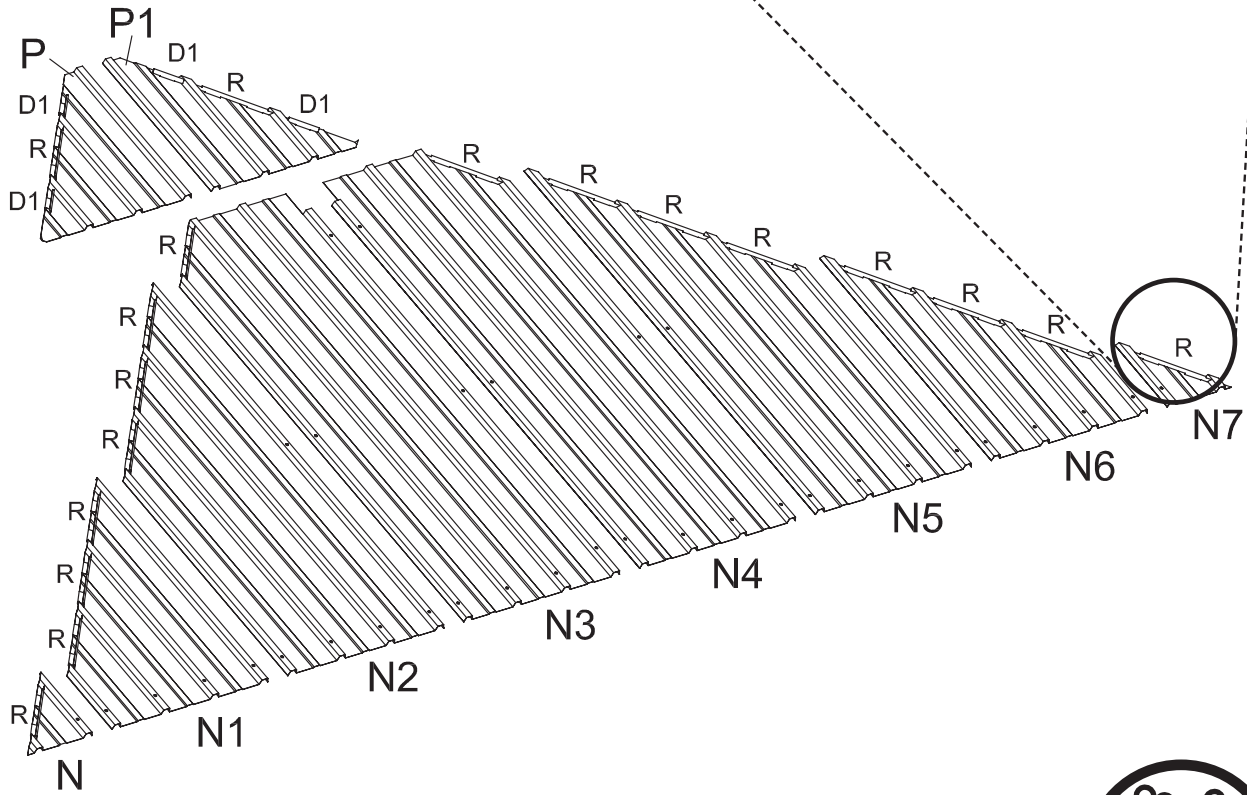
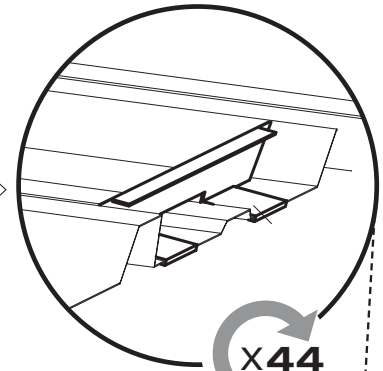
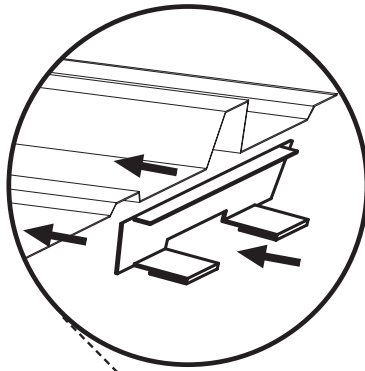

Nx2	N1x2	N2x2	N3x2	N4x2	N5x2	N6x2	N7x2	Px2	P1x2	Rx36	D1x8
-----	------	------	------	------	------	------	------	-----	------	------	------

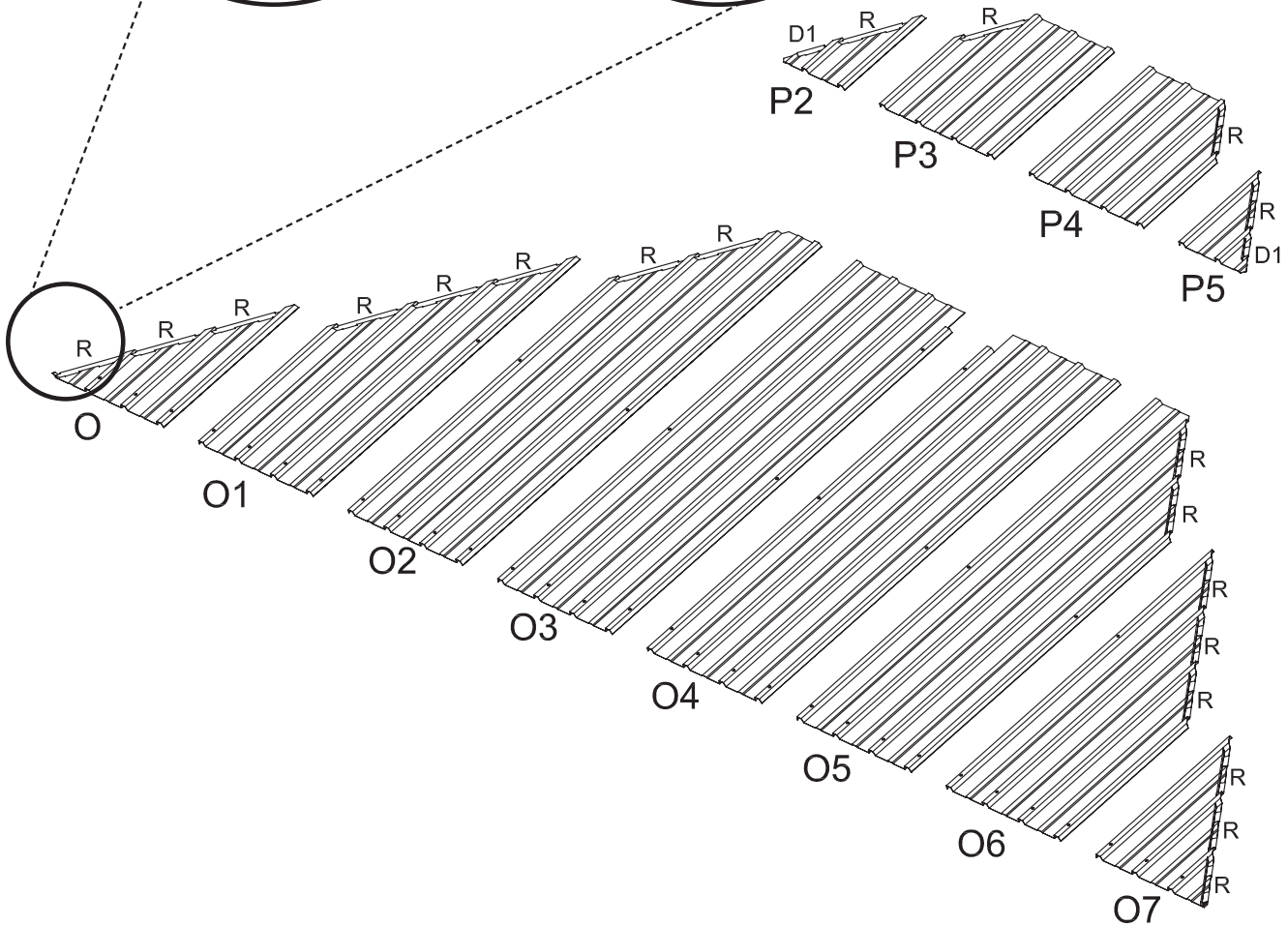
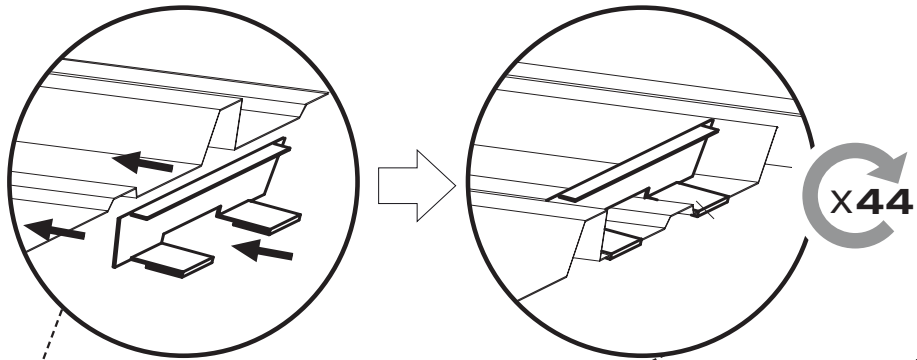

O0x2 O1x2 O2x2 O3x2 O4x2 O5x2 O6x2 O7x2

P2x2 P3x2 P4x2 P5x2

Rx40 D1x4

